

Dell OptiPlex 7020 Small Form Factor Owner's Manual

Regulatory Model: D07S
Regulatory Type: D07S001



Notes, Cautions, and Warnings

 **NOTE:** A NOTE indicates important information that helps you make better use of your computer.

 **CAUTION:** A CAUTION indicates either potential damage to hardware or loss of data and tells you how to avoid the problem.

 **WARNING:** A WARNING indicates a potential for property damage, personal injury, or death.

Copyright © 2014 Dell Inc. All rights reserved. This product is protected by U.S. and international copyright and intellectual property laws. Dell™ and the Dell logo are trademarks of Dell Inc. in the United States and/or other jurisdictions. All other marks and names mentioned herein may be trademarks of their respective companies.

2014 - 07

Rev. A00

Contents

1 Working on Your Computer.....	5
Before Working Inside Your Computer.....	5
Turning Off Your Computer.....	6
After Working Inside Your Computer.....	7
2 Removing and Installing Components.....	8
Recommended Tools.....	8
System Overview.....	8
Front, Back, and Inside View.....	8
Removing the Cover.....	10
Installing the Cover.....	11
Removing the Front Bezel.....	11
Installing the Front Bezel.....	11
Removing The Expansion Card.....	11
Installing The Expansion Card.....	13
Removing the Wireless Local Area Network (WLAN) Card.....	13
Installing the WLAN Card.....	14
Removing the Optical Drive.....	14
Installing the Optical Drive.....	15
Removing the Drive Cage.....	15
Installing the Drive Cage.....	16
Removing the Hard Drive.....	17
Installing the Hard Drive.....	17
Removing the Speaker.....	18
Installing the Speaker.....	18
Memory Module Guidelines.....	19
Removing the Memory.....	19
Installing the Memory.....	19
Removing the System Fan.....	19
Installing the System Fan.....	20
Removing the Power Switch.....	21
Installing the Power Switch.....	22
Removing the Input/Output (I/O) Panel.....	22
Installing the Input/Output (I/O) Panel.....	23
Removing the Power Supply.....	23
Installing the Power Supply.....	25
Removing the Coin-Cell Battery.....	26
Installing the Coin-Cell Battery.....	26

Removing the Heat Sink Assembly.....	26
Installing the Heat Sink Assembly.....	27
Removing the Processor.....	28
Installing the Processor.....	28
Removing the Intrusion Switch.....	28
Installing the Intrusion Switch.....	29
Removing the System Board.....	29
Installing the System Board.....	30
System Board Layout.....	31
3 System Setup.....	33
Boot Sequence.....	33
Navigation Keys.....	33
System Setup Options.....	34
Updating the BIOS	42
Jumper Settings.....	43
System and Setup Password.....	43
Assigning a System Password and Setup Password.....	44
Deleting or Changing an Existing System and/or Setup Password.....	44
Disabling a System Password.....	45
4 Diagnostics.....	46
Enhanced Pre-Boot System Assessment (ePSA) Diagnostics.....	46
5 Troubleshooting Your Computer.....	47
Power LED Diagnostics.....	47
Beep Code.....	48
Error Messages.....	48
6 Specifications.....	52
7 Contacting Dell.....	58

Working on Your Computer

Before Working Inside Your Computer

Use the following safety guidelines to help protect your computer from potential damage and to help to ensure your personal safety. Unless otherwise noted, each procedure included in this document assumes that the following conditions exist:

- You have read the safety information that shipped with your computer.
- A component can be replaced or--if purchased separately--installed by performing the removal procedure in reverse order.

 **WARNING:** Disconnect all power sources before opening the computer cover or panels. After you finish working inside the computer, replace all covers, panels, and screws before connecting to the power source.

 **WARNING:** Before working inside your computer, read the safety information that shipped with your computer. For additional safety best practices information, see the Regulatory Compliance Homepage at www.dell.com/regulatory_compliance

 **CAUTION:** Many repairs may only be done by a certified service technician. You should only perform troubleshooting and simple repairs as authorized in your product documentation, or as directed by the online or telephone service and support team. Damage due to servicing that is not authorized by Dell is not covered by your warranty. Read and follow the safety instructions that came with the product.

 **CAUTION:** To avoid electrostatic discharge, ground yourself by using a wrist grounding strap or by periodically touching an unpainted metal surface, such as a connector on the back of the computer.

 **CAUTION:** Handle components and cards with care. Do not touch the components or contacts on a card. Hold a card by its edges or by its metal mounting bracket. Hold a component such as a processor by its edges, not by its pins.

 **CAUTION:** When you disconnect a cable, pull on its connector or on its pull-tab, not on the cable itself. Some cables have connectors with locking tabs; if you are disconnecting this type of cable, press in on the locking tabs before you disconnect the cable. As you pull connectors apart, keep them evenly aligned to avoid bending any connector pins. Also, before you connect a cable, ensure that both connectors are correctly oriented and aligned.

 **NOTE:** The color of your computer and certain components may appear differently than shown in this document.

To avoid damaging your computer, perform the following steps before you begin working inside the computer.

1. Ensure that your work surface is flat and clean to prevent the computer cover from being scratched.
2. Turn off your computer (see Turning Off Your Computer).





⚠ CAUTION: To disconnect a network cable, first unplug the cable from your computer and then unplug the cable from the network device.

3. Disconnect all network cables from the computer.
4. Disconnect your computer and all attached devices from their electrical outlets.
5. Press and hold the power button while the computer is unplugged to ground the system board.
6. Remove the cover.

⚠ CAUTION: Before touching anything inside your computer, ground yourself by touching an unpainted metal surface, such as the metal at the back of the computer. While you work, periodically touch an unpainted metal surface to dissipate static electricity, which could harm internal components.

Turning Off Your Computer

⚠ CAUTION: To avoid losing data, save and close all open files and exit all open programs before you turn off your computer.

1. Shut down the operating system:
 - In Windows 8:
 - Using a touch-enabled device:
 - a. Swipe in from the right edge of the screen, opening the Charms menu and select **Settings**.
 - b. Select the  and then select **Shut down**
 - Using a mouse:
 - a. Point to upper-right corner of the screen and click **Settings**.
 - b. Click the  and select **Shut down**.
 - In Windows 7:
 1. Click **Start** .
 2. Click **Shut Down**.or
 1. Click **Start** .
 2. Click the arrow in the lower-right corner of the **Start** menu as shown below, and then click **Shut Down..** 
2. Ensure that the computer and all attached devices are turned off. If your computer and attached devices did not automatically turn off when you shut down your operating system, press and hold the power button for about 6 seconds to turn them off.

After Working Inside Your Computer

After you complete any replacement procedure, ensure you connect any external devices, cards, and cables before turning on your computer.

1. Replace the cover.



CAUTION: To connect a network cable, first plug the cable into the network device and then plug it into the computer.

2. Connect any telephone or network cables to your computer.
3. Connect your computer and all attached devices to their electrical outlets.
4. Turn on your computer.
5. If required, verify that the computer works correctly by running the Dell Diagnostics.

Removing and Installing Components

This section provides detailed information on how to remove or install the components from your computer.

Recommended Tools

The procedures in this document may require the following tools:

- Small flat-blade screwdriver
- Phillips screwdriver
- Small plastic scribe

System Overview

The figure below displays the inside view of the Small Form Factor after the base cover has been removed. The call outs show the names and the layout of the components inside the computer.

Front, Back, and Inside View

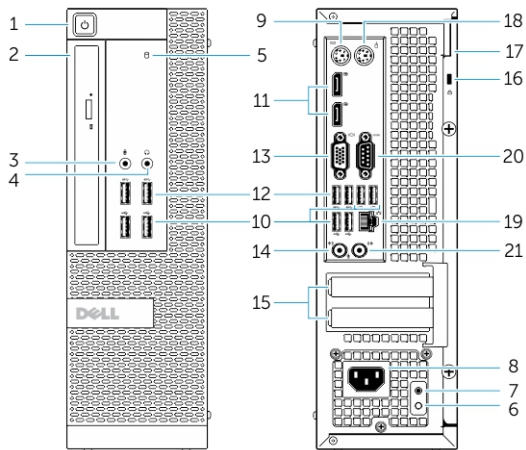

Figure 1. Front and Back View

1. power button or power light
2. flex bay
3. microphone connector
4. headphone connector
5. hard-drive activity light
6. power-supply diagnostic light

- 7. power-supply diagnostic button
- 8. power cable connector
- 9. keyboard connector
- 10. USB 2.0 connector
- 11. display port connector
- 12. USB 3.0 connector
- 13. VGA connector
- 14. line-in or microphone connector
- 15. expansion-card slots
- 16. security-cable slot
- 17. padlock ring
- 18. mouse connector
- 19. network connector
- 20. serial connector
- 21. line-out connector

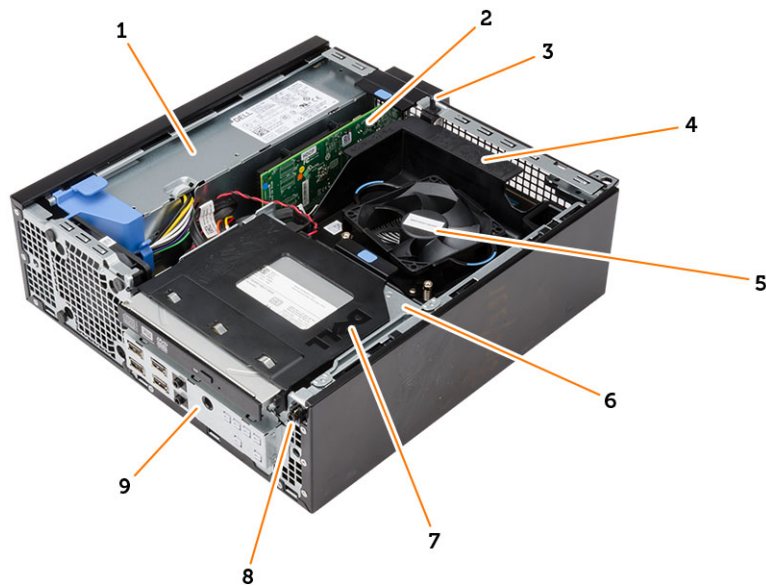
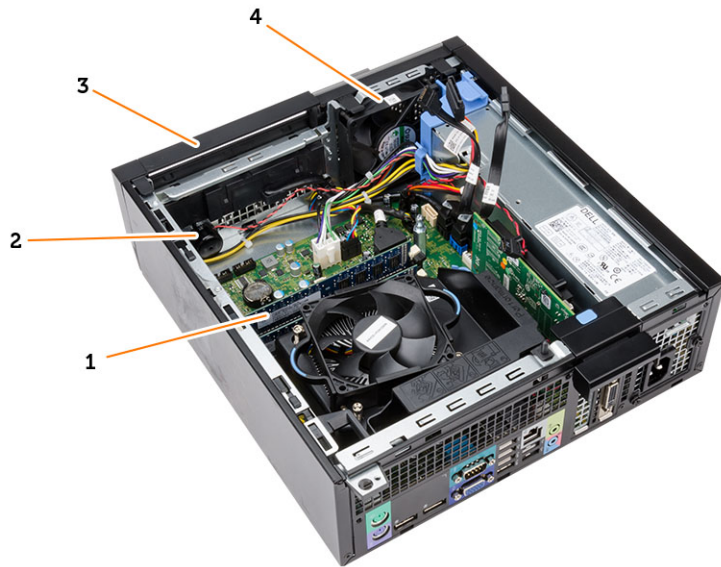

Figure 2. Inside View

- 1. power supply
- 2. PCI Express Card
- 3. intrusion switch
- 4. processor-fan cover
- 5. processor fan
- 6. drive cage
- 7. optical drive
- 8. power switch
- 9. input/output (I/O) Panel



- | | |
|------------------|---------------|
| 1. memory module | 2. speaker |
| 3. front bezel | 4. system fan |

Removing the Cover

1. Follow the procedures in *Before Working Inside Your Computer*.
2. Pull-up the cover-release latch and lift the cover. Lift the cover upward to a 45-degree angle and remove it from the computer.



Installing the Cover

1. Place the cover on the chassis.
2. Press down on the cover till it clicks into place.
3. Follow the procedures in *After Working Inside Your Computer*.

Removing the Front Bezel

1. Follow the procedures in *Before Working Inside Your Computer*.
2. Remove the cover.
3. Pry the front bezel retention clips away from the chassis.
4. Rotate the bezel away from the computer to release the hooks on the opposite edge of the bezel from the chassis. Then, lift the chassis and remove the front bezel from the computer.

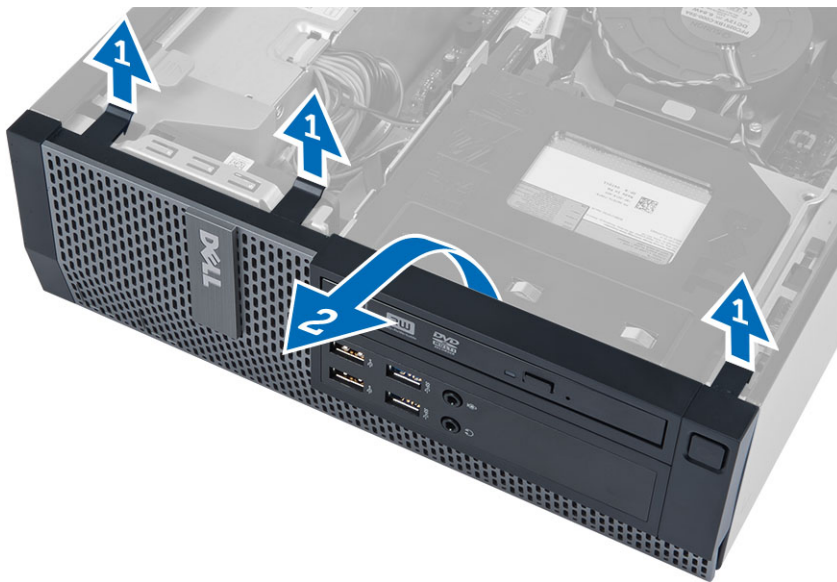

Installing the Front Bezel

1. Insert the hooks along the bottom edge of the front bezel into the slots on the chassis front.
2. Push the bezel toward the computer to engage the front bezel retention clips until they click into place.
3. Install the cover.
4. Follow the procedures in *After Working Inside Your Computer*.

Removing The Expansion Card

1. Follow the procedures in *Before Working Inside Your Computer*.
2. Remove the cover
3. Rotate the release tab on the card-retention latch upward.

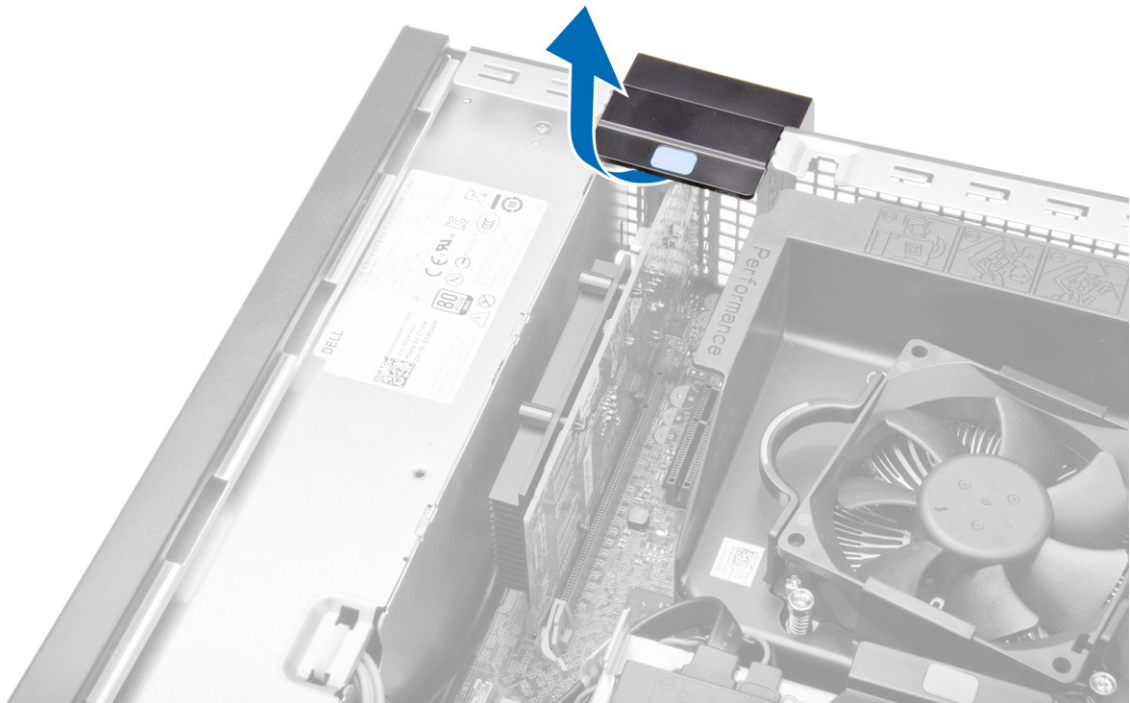

4. Pull the release lever away from the expansion card until you release the securing tab from the dent in the card. Then, ease the card up and out of its connector and remove it from the computer.

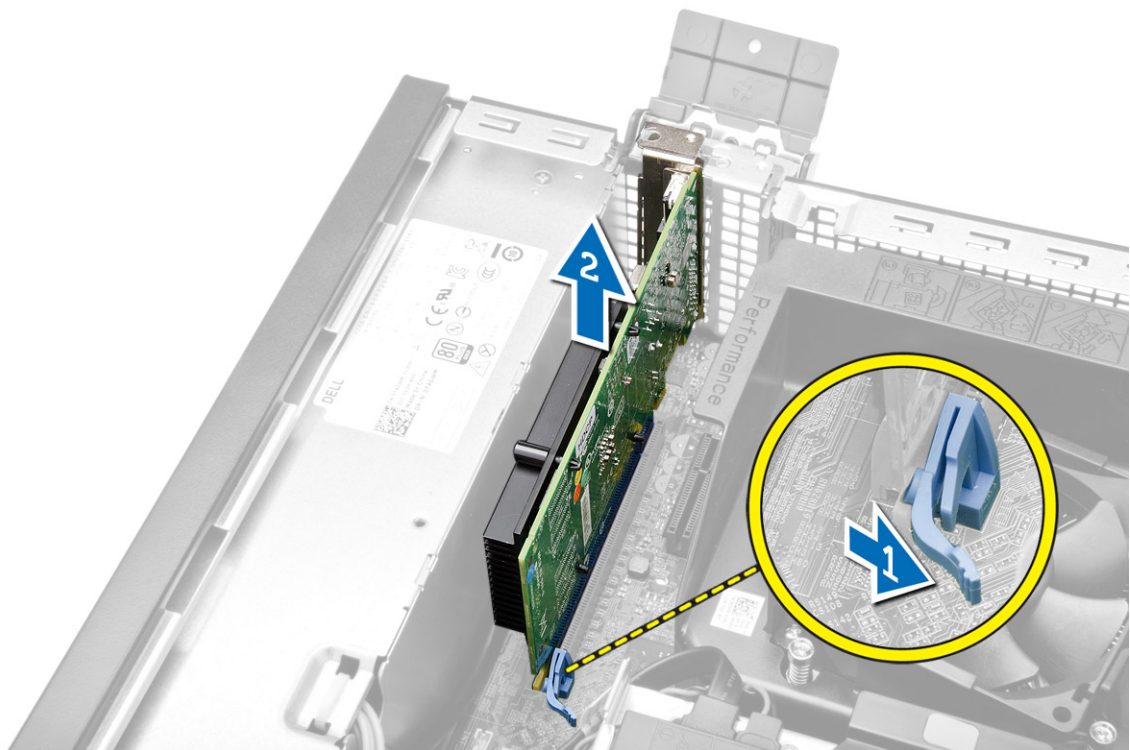

Installing The Expansion Card

1. Insert the expansion card into the connector on the system board and press down to secure it in place.
2. Install the cover
3. Follow the procedures in *After Working Inside Your Computer*.

Removing the Wireless Local Area Network (WLAN) Card

1. Follow the procedures in *Before Working Inside Your Computer*.
2. Remove the cover.
3. Remove the screws that secure the antenna puck to the computer.
4. Pull the antenna puck from the computer.



5. Press the blue tab and lift the latch outwards. Lift and remove the WLAN card from the connector on the system board.

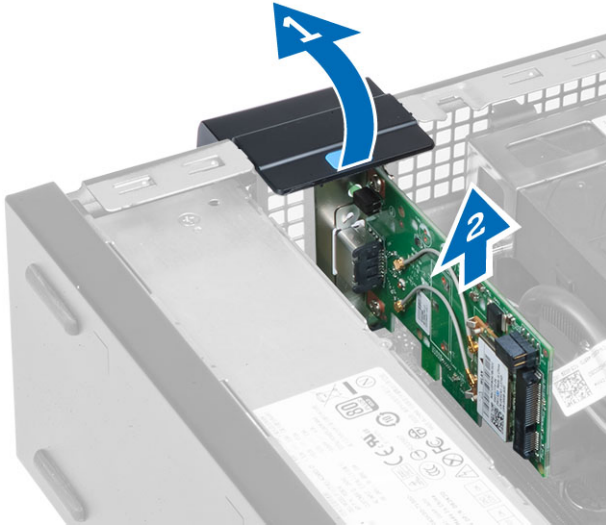

Installing the WLAN Card

1. Place the WLAN card on the connector and press down.
2. Press the latch to secure the WLAN card.
3. Place the antenna puck on the connector and tighten the screws that secure it to the computer.
4. Install the cover.
5. Follow the procedures in *After Working Inside Your Computer*.

Removing the Optical Drive

1. Follow the procedures in *Before Working Inside Your Computer*.
2. Remove the cover.
3. Disconnect the data and power cables from the back of the optical drive.
4. Lift the tab and slide the optical drive out to remove it from the computer.

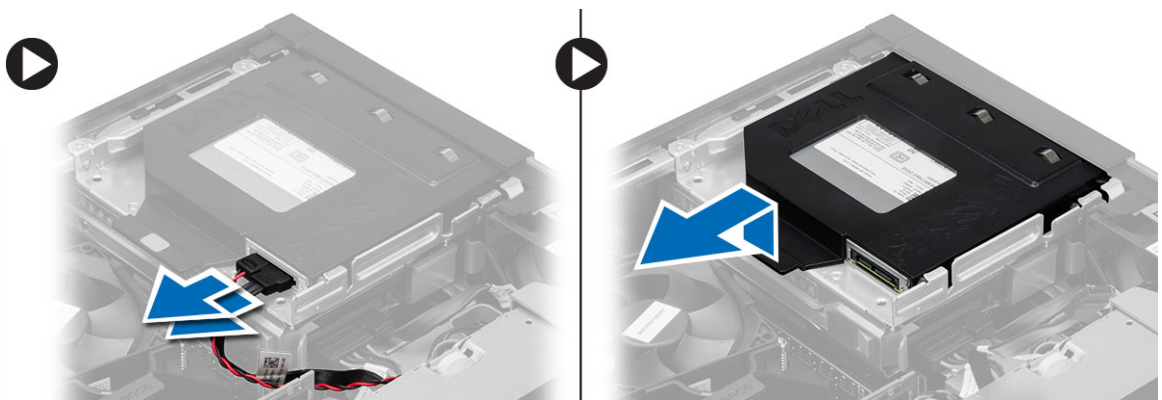

5. Flex the optical-drive bracket and then lift the optical drive from the bracket

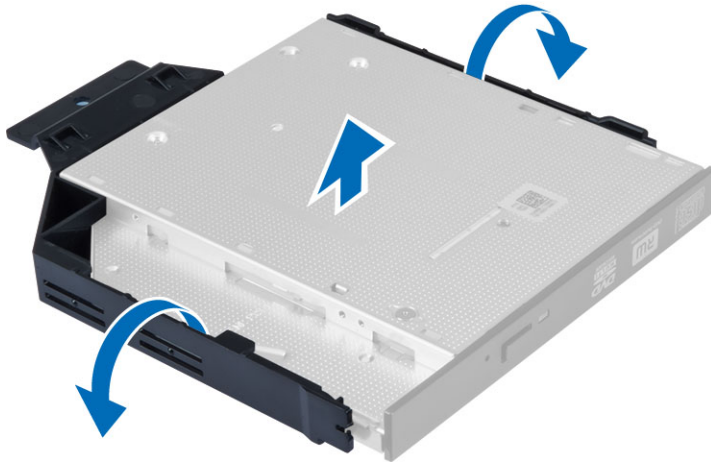

6. Repeat steps 3 to 5 to remove the second optical drive (if available).

Installing the Optical Drive

1. Insert the optical drive into the bracket.
2. Slide the optical drive to insert it into the drive cage.
3. Connect the data and power cables to the optical drive.
4. Install the cover.
5. Follow the procedures in *After Working Inside Your Computer*.

Removing the Drive Cage

1. Follow the procedures in *Before Working Inside Your Computer*.
2. Remove the:
 - a. cover
 - b. front bezel
 - c. optical drive
3. Disconnect the data and the power cables from the back of the hard drive.

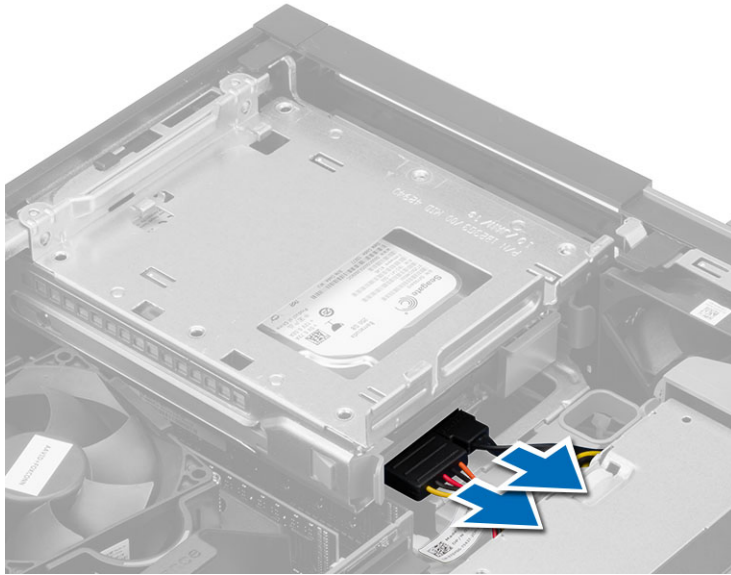

4. Slide the blue drive-cage handle toward unlock position and lift the hard drive cage from the computer.

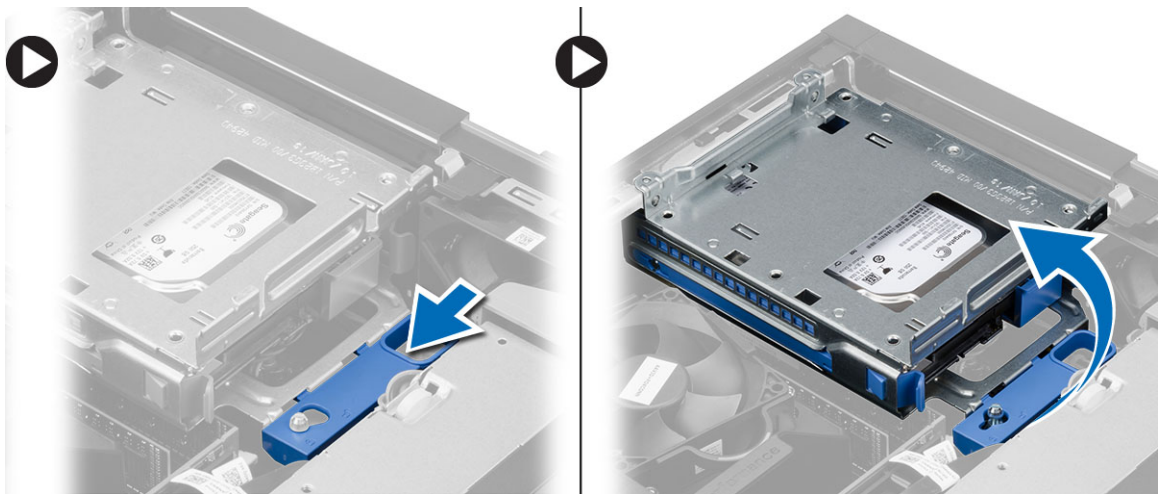

Installing the Drive Cage

1. Place the drive cage on the edge of the computer to allow access to the cable connectors on the hard drive.
2. Connect the data and power cables to the back of the hard drive.
3. Flip over the drive cage and insert it into the chassis. The drive cage tabs are secured by the slots in the chassis.
4. Slide the drive-cage handle toward the locked position.
5. Install the:
 - a. front bezel
 - b. optical drive
 - c. cover

6. Follow the procedures in *After Working Inside Your Computer*.

Removing the Hard Drive

1. Follow the procedures in *Before Working Inside Your Computer*.
2. Remove the:
 - a. cover
 - b. optical drive
 - c. drive cage
3. Press the retention clips inwards and slide the hard-drive bracket out from the drive cage.

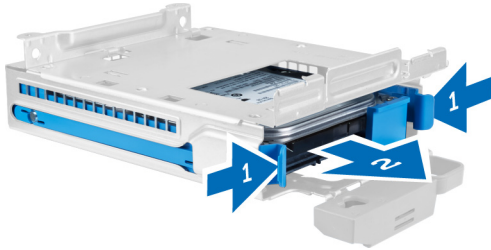

4. Flex the hard-drive bracket and remove the hard drive from the bracket.



5. Remove the screws that secure the mini hard drive to the hard-drive bracket and remove the hard drive from its bracket.



 **NOTE:** Perform step 5 only if you have a mini hard drive.

Installing the Hard Drive

1. Tighten the screws to secure the mini hard drive (if available) to the hard-drive bracket.
2. Flex the hard-drive bracket and then insert the hard drive into the bracket.

3. Slide the hard-drive bracket into the drive cage.
4. Install the:
 - a. drive cage
 - b. optical drive
 - c. cover
5. Follow the procedures in *After Working Inside Your Computer*.

Removing the Speaker

1. Follow the procedures in *Before Working Inside Your Computer*.
2. Remove the:
 - a. cover
 - b. optical drive
 - c. drive cage
3. Disconnect the speaker cable from the system board and release it from the securing tab inside the chassis. Press the speaker-securing tab, and slide the speaker towards the right of the computer to release it.

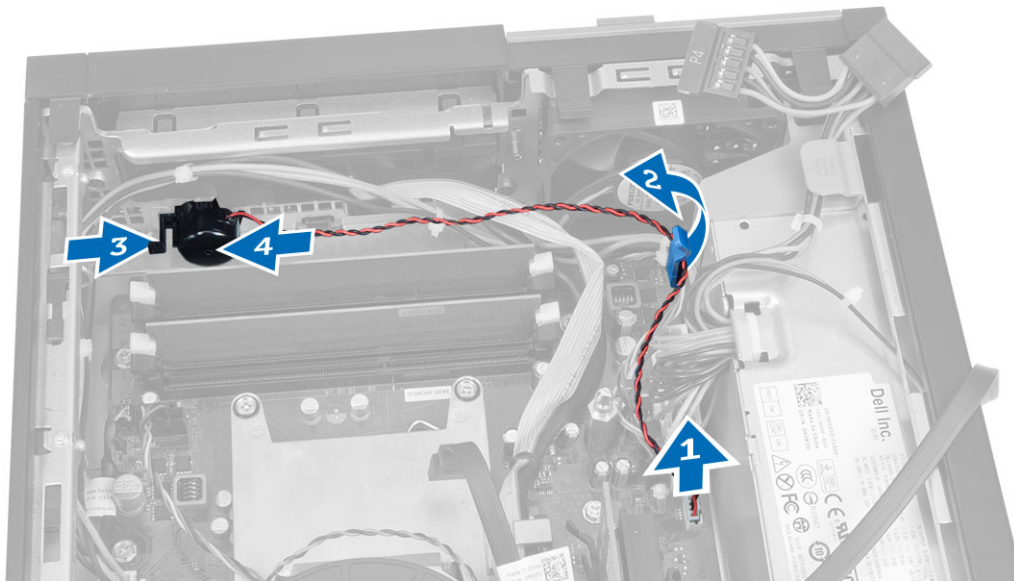

Installing the Speaker

1. Place the speaker at the appropriate location on the chassis.
2. Press the speaker-securing tab and slide the speaker towards the left of the computer to secure it.
3. Guide the speaker cable through the securing tab and connect the speaker cable to the system board.
4. Install the:
 - a. drive cage
 - b. optical drive
 - c. cover
5. Follow the procedures in *After Working Inside Your Computer*.

Memory Module Guidelines

To ensure optimal performance of your computer, observe the following general guidelines when configuring your system memory:

- Memory modules of different sizes can be mixed (for example, 2 GB and 4 GB). But, all populated channels must have identical configurations.
- Memory modules must be installed beginning with the first socket.
 - ✎ **NOTE:** The memory sockets in your computer may be labeled differently depending on the hardware configuration. For example, A1, A2 or 1,2,3.
- If the quad-rank memory modules are mixed with single or dual-rank modules, the quad-rank modules must be installed in the sockets with the white release levers.
- If memory modules with different speeds are installed, they operate at the speed of the slowest installed memory modules.

Removing the Memory

1. Follow the procedures in *Before Working Inside Your Computer*.
2. Remove the cover.
3. Press down on the memory retaining tabs on each side of the memory modules, and lift the memory modules out of the connectors on the system board.

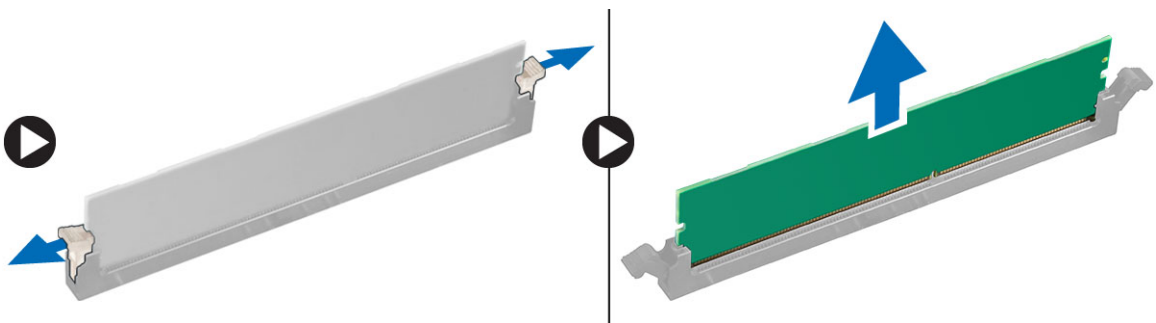

Installing the Memory

1. Align the notch on the memory-card with the tab in the system-board connector.
2. Press down on the memory module until the release tabs spring back to secure them in place.
3. Install the cover.
4. Follow the procedures in *After Working Inside Your Computer*.

Removing the System Fan

1. Follow the procedures in *Before Working Inside Your Computer*.
2. Remove
 - a. cover
 - b. optical drive
 - c. drive cage
 - d. front bezel

3. Disconnect the system-fan cable from the system board.

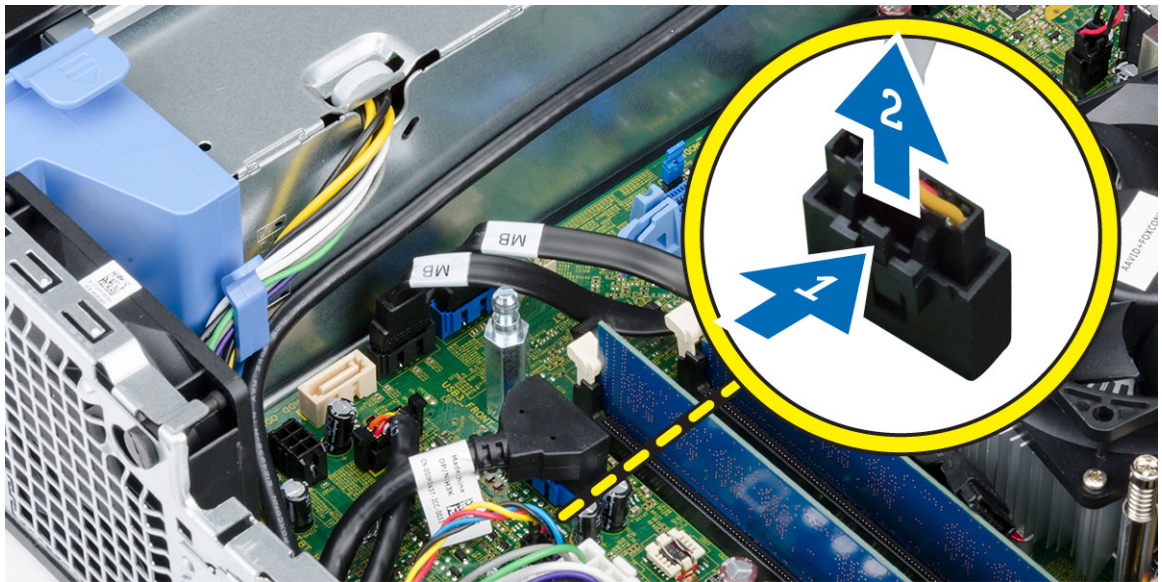

4. Pry and remove the system fan away from the grommets securing it to the front of the computer. Then, press the grommets inward along the slots and pass through the chassis.

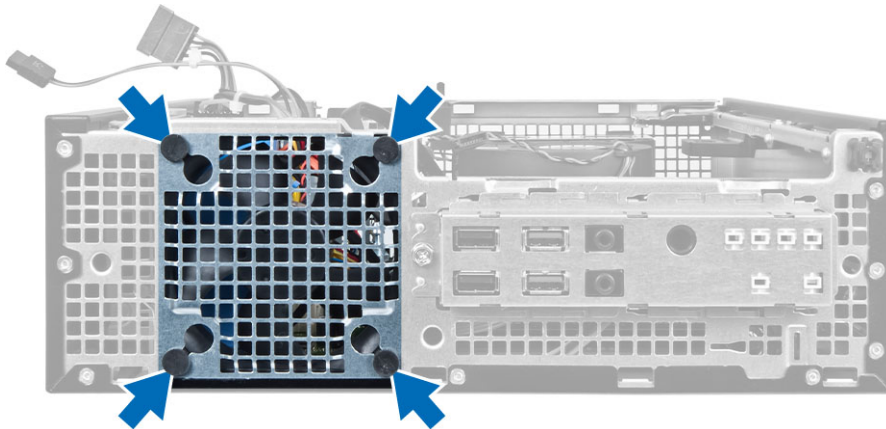

Installing the System Fan

1. Place the system-fan in the chassis.
2. Pass the grommets through the chassis and slide outward along the groove to secure it in place.
3. Connect the system-fan cable to the system board.
4. Install:
 - a. front bezel
 - b. drive cage
 - c. optical drive
 - d. cover
5. Follow the procedures in *After Working Inside Your Computer*.

Removing the Power Switch

1. Follow the procedures in *Before Working Inside Your Computer*.
2. Remove the:
 - a. cover
 - b. front bezel
 - c. optical drive
 - d. drive cage
3. Disconnect the power-switch cable from the system board.

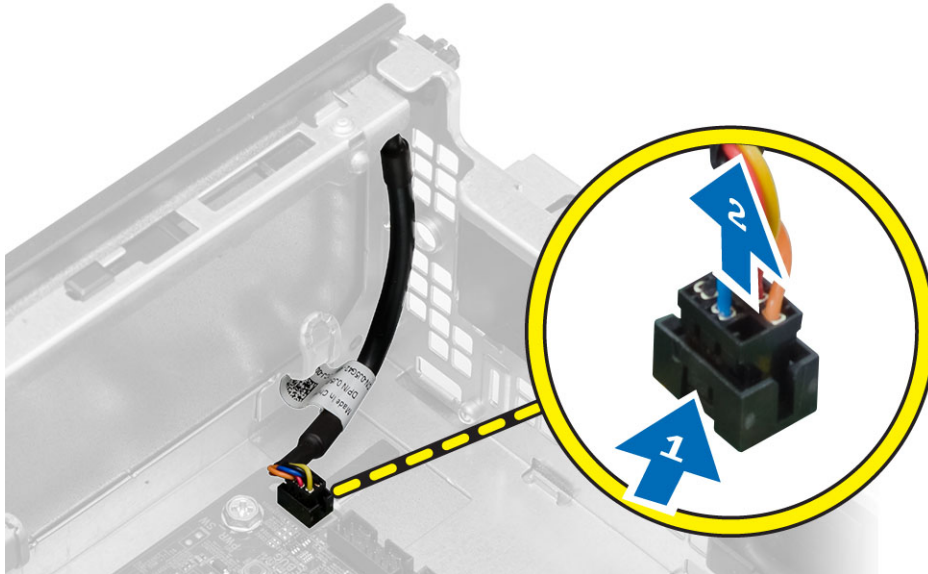

4. Press the clips on both side of the power switch to release it from the chassis and remove the power switch along with its cable from the computer.

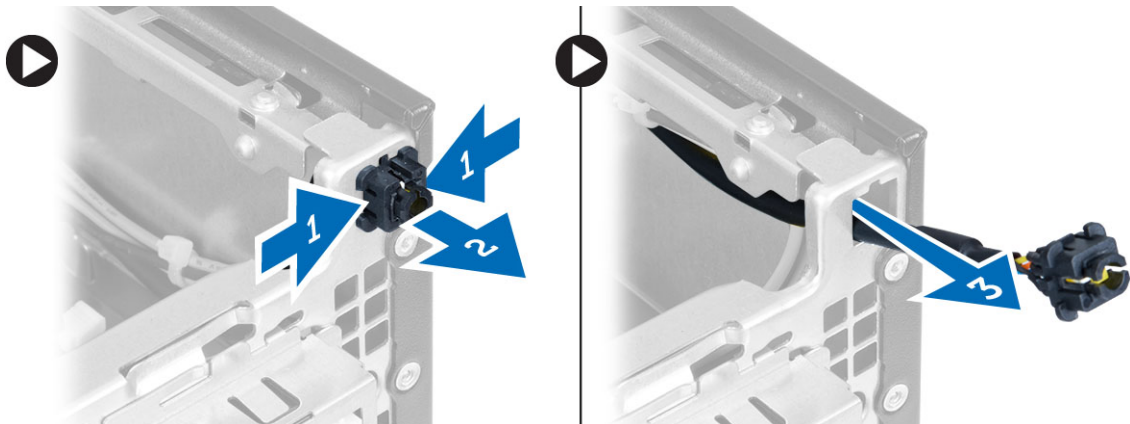

Installing the Power Switch

1. Slide the power switch in through the front of the computer.
2. Connect the power-switch cable to the system board.
3. Install the:
 - a. drive cage
 - b. optical drive
 - c. front bezel
 - d. cover
4. Follow the procedures in *After Working Inside Your Computer*.

Removing the Input/Output (I/O) Panel

1. Follow the procedures in *Before Working Inside Your Computer*.
2. Remove the:
 - a. cover
 - b. optical drive
 - c. drive cage
 - d. front bezel
3. Disconnect the I/O panel or FlyWire cable and the audio cable from the system board.

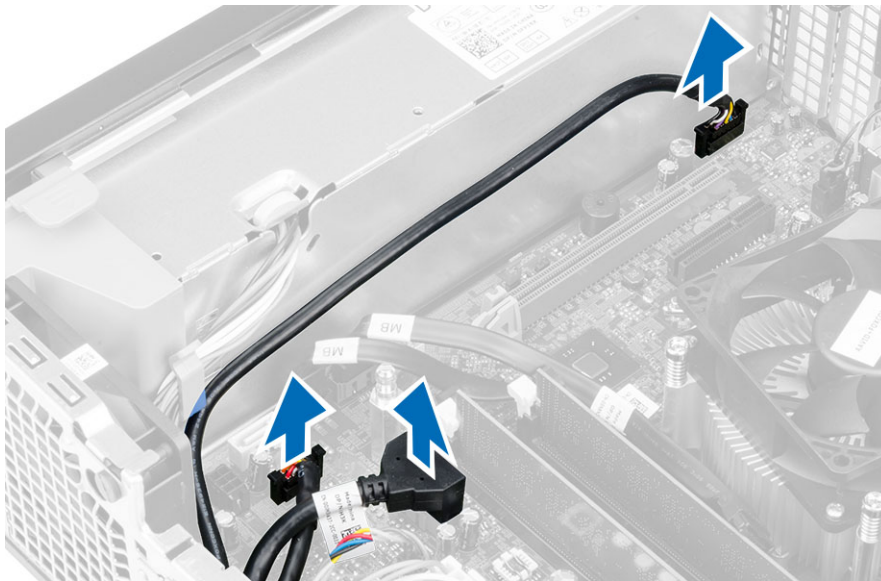

4. Remove the screw that secures the I/O panel to the chassis. Then, slide the I/O panel to release and remove it from the computer.

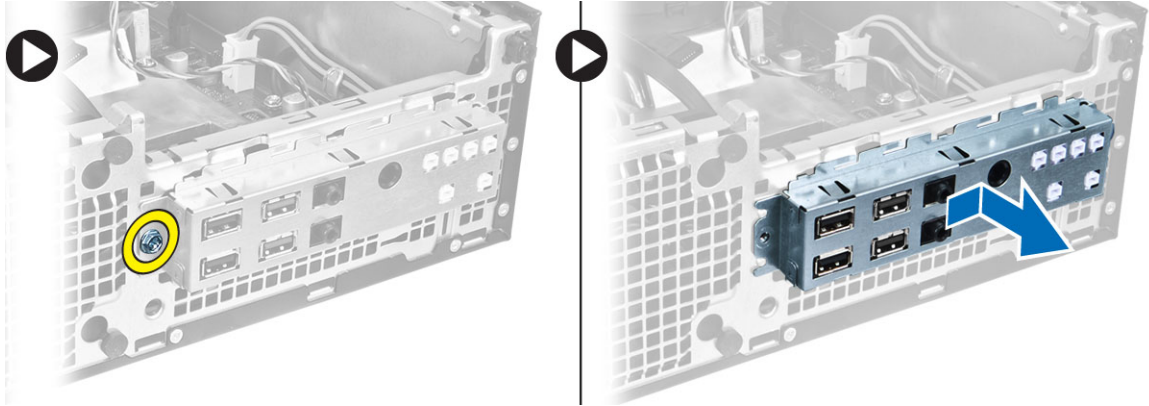

Installing the Input/Output (I/O) Panel

1. Insert the I/O panel into the slot on the chassis front.
2. Slide the I/O panel to secure it to the chassis.
3. Tighten the screw to secure the I/O panel to the chassis.
4. Connect the I/O panel or FlyWire cable and audio cable to the system board.
5. Thread the I/O panel or FlyWire cable into the fan-shelter clip.
6. Install the:
 - a. drive cage
 - b. optical drive
 - c. front bezel
 - d. cover
7. Follow the procedures in *After Working Inside Your Computer*.

Removing the Power Supply

1. Follow the procedures in *Before Working Inside Your Computer*.
2. Remove the:
 - a. cover
 - b. front bezel
 - c. optical drive
 - d. drive cage
3. Disconnect the 8-pin power cables from the system board.

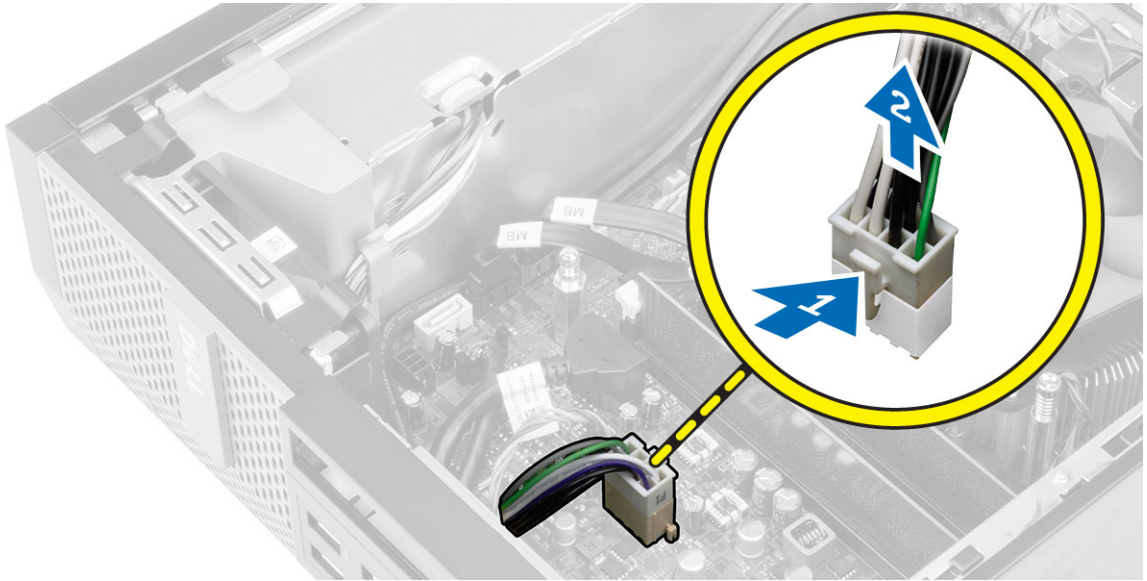

4. Disconnect the 4-pin power cables from the system board.

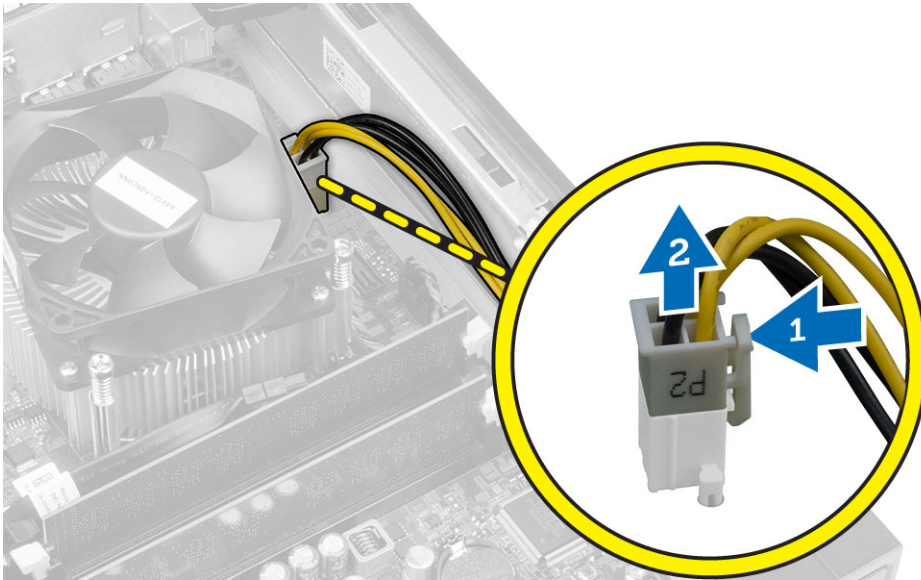

5. Remove the screws that secure the power supply to the back of the computer.

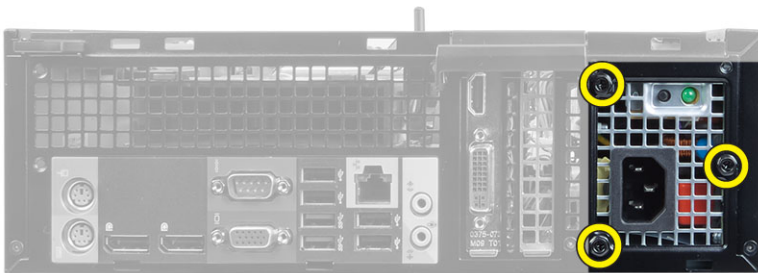

6. Push in on the blue release tab and slide the power supply towards the front of the computer.

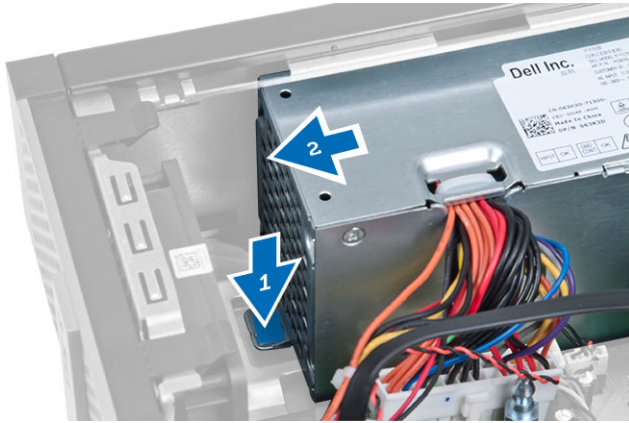

7. Lift the power supply out of the computer

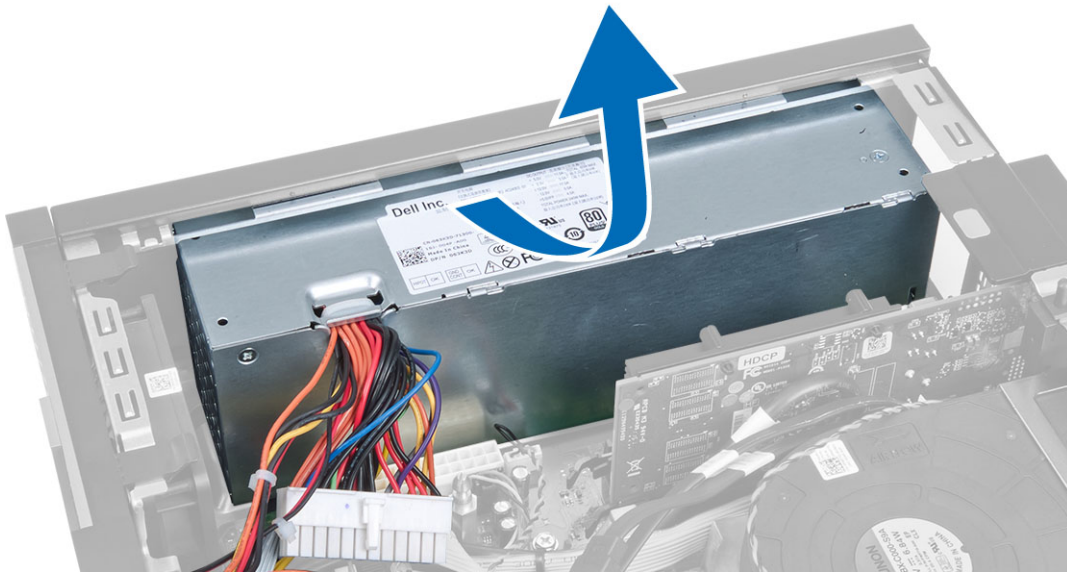

Installing the Power Supply

1. Place the power supply in the chassis and slide towards the back of the computer to secure it.
2. Tighten the screws securing the power supply to the back of the computer.
3. Connect the 4-pin and 8-pin power cables to the system board.
4. Thread the power cables into the chassis clips.
5. Install the:
 - a. drive cage
 - b. optical drive
 - c. front bezel
 - d. cover
6. Follow the procedures in *After Working Inside Your Computer*.

Removing the Coin-Cell Battery

1. Follow the procedures in *Before Working Inside Your Computer*.
2. Remove the:
 - a. cover
 - b. front bezel
 - c. drive cage
3. Press the release latch away from the battery to allow it to pop-up from the socket and then lift the coin-cell battery out of the computer.

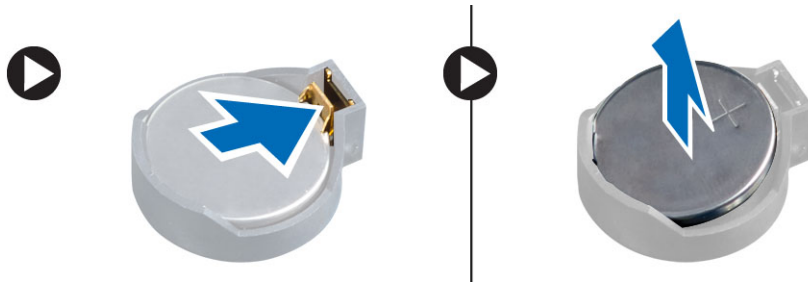

Installing the Coin-Cell Battery

1. Place the coin-cell battery into its slot on the system board.
2. Press the coin-cell battery downward until the release latch springs back into place and secures it.
3. Install the:
 - a. drive cage
 - b. front bezel
 - c. cover
4. Follow the procedures in *After Working Inside Your Computer*.

Removing the Heat Sink Assembly

1. Follow the procedures in *Before Working Inside Your Computer*.
2. Remove the cover
3. Using both hands, push away the two release handles while lifting the fan shroud upward and off the computer.

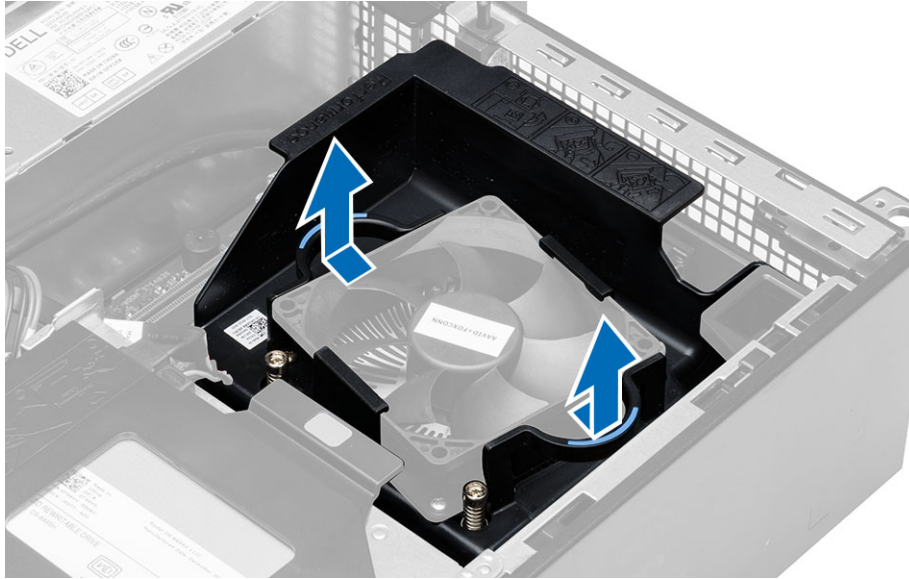

4. Disconnect the fan cable from the system board. Loosen the captive screws, lift the heat sink assembly and then remove it from the computer.

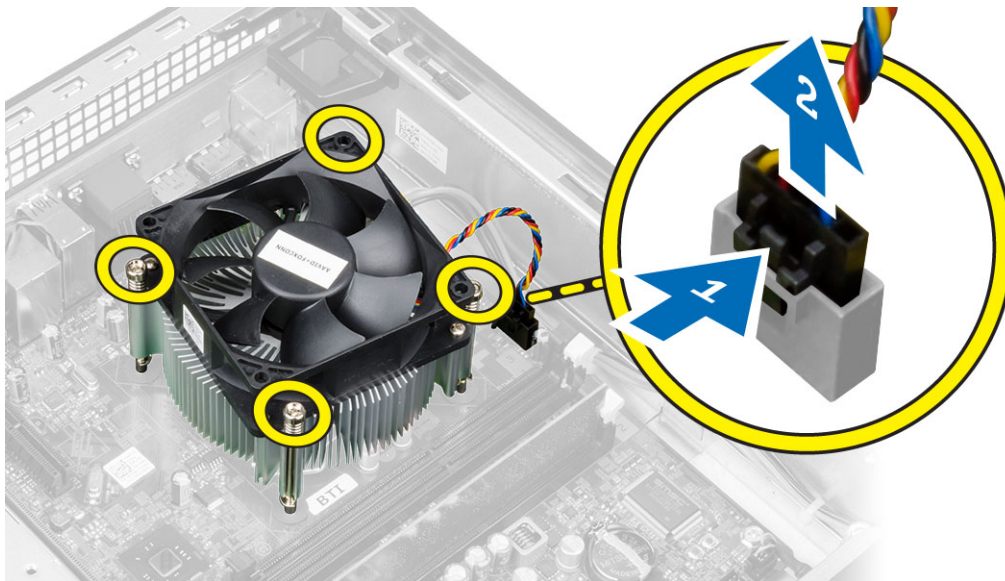

Installing the Heat Sink Assembly

1. Place the heat-sink assembly into the chassis.
2. Tighten the captive screws to secure the heat-sink assembly to the system board.
3. Connect the fan cable to the system board.
4. Place the fan shroud on the fan and push to click in place.
5. Install the cover
6. Follow the procedures in *After Working Inside Your Computer*.

Removing the Processor

1. Follow the procedures in *Before Working Inside Your Computer*.
2. Remove the cover.
3. Remove the heat sink assembly.
4. Press the release lever down and then move it outward to release it from the retention hook. Lift the processor cover and remove the processor from the socket, and place it in antistatic bag.



Installing the Processor

1. Insert the processor into the processor socket. Ensure the processor is properly seated.
2. Gently lower the processor cover.
3. Press the release lever down and then move it inward to secure it with the retention hook.
4. Install the heat-sink assembly.
5. Install the cover.
6. Follow the procedures in *After Working Inside Your Computer*.

Removing the Intrusion Switch

1. Follow the procedures in *Before Working Inside Your Computer*.
2. Remove the:
 - a. cover
 - b. heat sink assembly
3. Disconnect the intrusion-switch cable from the system board.
4. Slide the intrusion switch toward the bottom of the chassis and remove it from the computer.

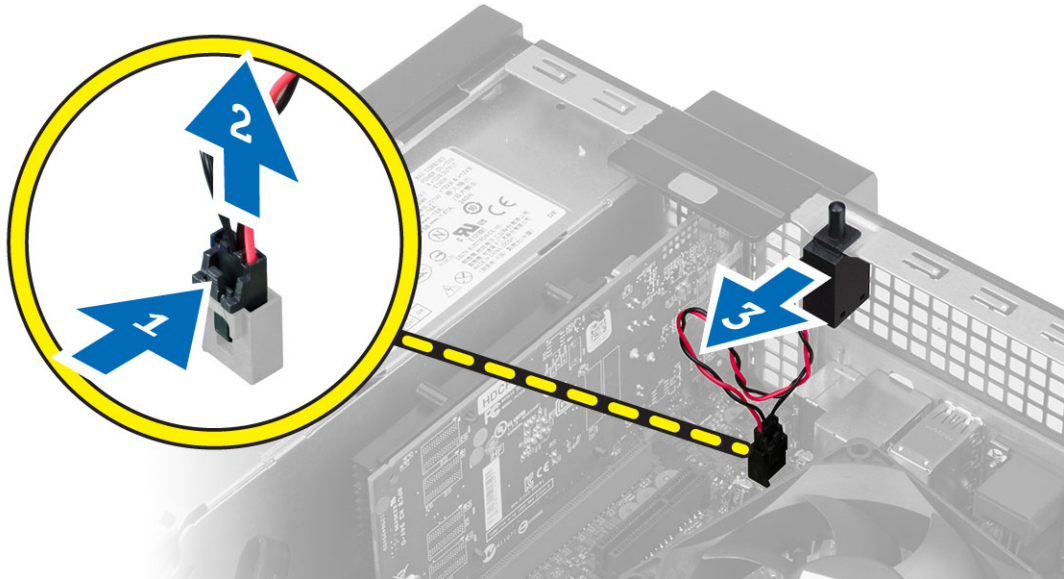

Installing the Intrusion Switch

1. Insert the intrusion-switch into the chassis rear and slide it outward to secure it.
2. Connect the intrusion-switch cable to the system board.
3. Install the:
 - a. heat sink assembly
 - b. cover
4. Follow the procedures in *After Working Inside Your Computer*.

Removing the System Board

1. Follow the procedures in *Before Working Inside Your Computer*.
2. Remove the:
 - a. cover
 - b. front bezel
 - c. optical drive
 - d. drive cage
 - e. memory
 - f. expansion card(s)
 - g. heatsink assembly
 - h. power supply
 - i. processor
3. Disconnect all the cables from the system board.
4. Turn the hex screw counter clockwise and remove from the system board.

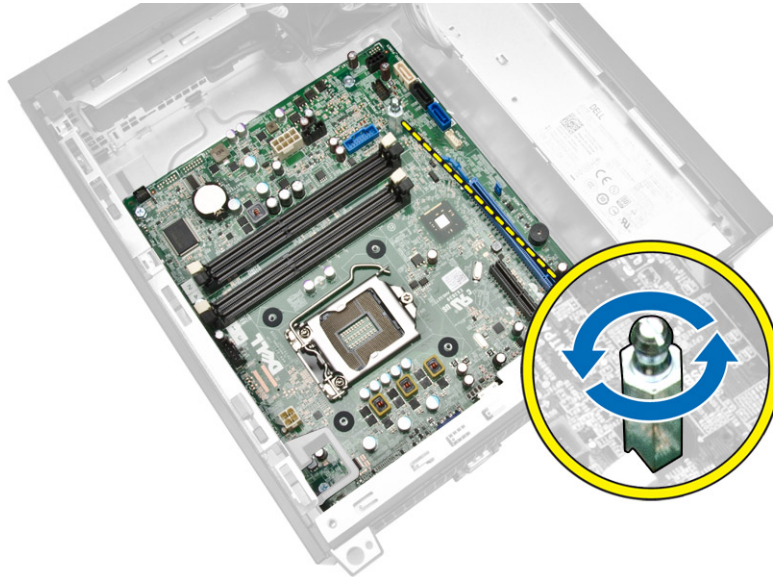

5. Remove the screws that secure the system board to the computer and slide the system board towards the front of the computer.

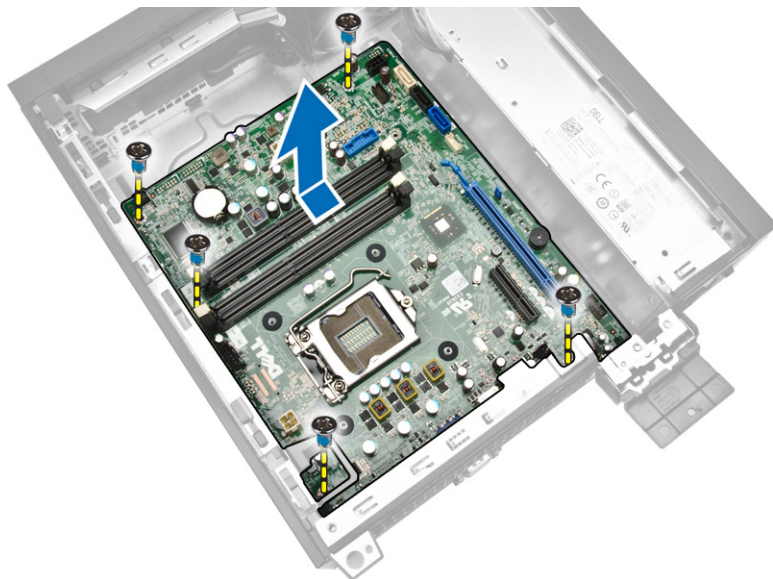

6. Tilt the system board at 45–degrees, and then lift the system board out of the computer.

Installing the System Board

1. Align the system board to the port connectors on the rear of the chassis and place the system board in the chassis.
2. Tighten the screws securing the system board to the chassis.
3. Tighten the hex screw to the system board.
4. Connect the cables to the system board.
5. Install the:

- a. processor
 - b. power supply
 - c. heat-sink assembly
 - d. expansion card(s)
 - e. memory
 - f. drive cage
 - g. optical drive
 - h. front bezel
 - i. cover
6. Follow the procedures in *After Working Inside Your Computer*.

System Board Layout

The following image displays the system board layout of the computer.

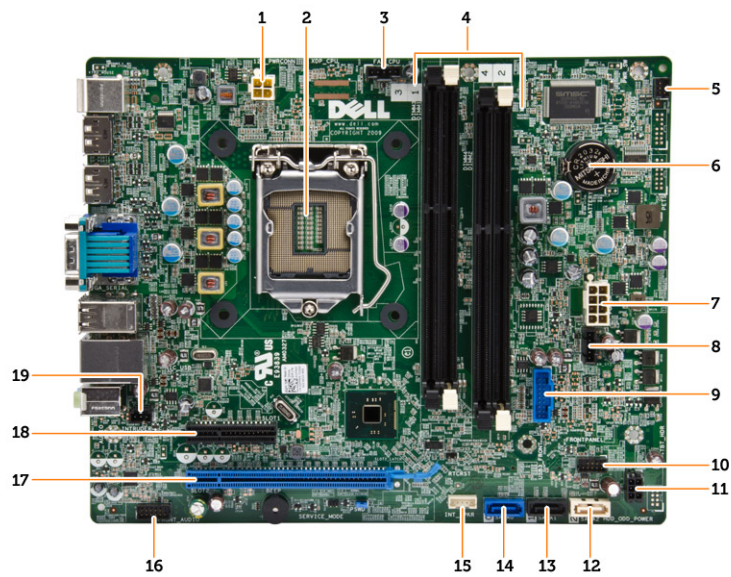

1. power connector
2. processor socket
3. system-fan connector
4. memory connectors (SODIMM sockets)
5. power switch connector
6. coin-cell battery
7. system power connector
8. heatsink-fan connector
9. front USB 3.0 connector
10. front panel connector
11. HDD/ODD power connector
12. SATA connector
13. SATA connector
14. SATA connector
15. internal speaker connector

16. front panel audio connector
17. PCI Express x16 connector
18. PCI Express x4 connector
19. intrusion-switch connector

System Setup

System Setup enables you to manage your computer hardware and specify BIOS-level options. From the System Setup, you can:

- Change the NVRAM settings after you add or remove hardware
- View the system hardware configuration
- Enable or disable integrated devices
- Set performance and power management thresholds
- Manage your computer security

Boot Sequence

Boot Sequence allows you to bypass the System Setup-defined boot device order and boot directly to a specific device (for example: optical drive or hard drive). During the Power-on Self Test (POST), when the Dell logo appears, you can:

- Access System Setup by pressing <F2> key
- Bring up the one-time boot menu by pressing <F12> key

The one-time boot menu displays the devices that you can boot from including the diagnostic option. The boot-menu options are:

- Removable Drive (if available)
- STXXXX Drive
 - ✎ **NOTE:** XXX denotes the SATA drive number.
- Optical Drive
- Diagnostics
 - ✎ **NOTE:** Choosing Diagnostics, will display the **ePSA diagnostics** screen.

The boot sequence screen also displays the option to access the System Setup screen.

Navigation Keys

The following table displays the system setup navigation keys.

- ✎ **NOTE:** For most of the system setup options, changes that you make are recorded but do not take effect until you re-start the system.

Table 1. Navigation Keys

Keys	Navigation
Up arrow	Moves to the previous field.
Down arrow	Moves to the next field.
<Enter>	Allows you to select a value in the selected field (if applicable) or follow the link in the field.
Spacebar	Expands or collapses a drop-down list, if applicable.
<Tab>	Moves to the next focus area.
	 NOTE: For the standard graphics browser only.
<Esc>	Moves to the previous page till you view the main screen. Pressing <Esc> in the main screen displays a message that prompts you to save any unsaved changes and restarts the system.
<F1>	Displays the System Setup help file.

System Setup Options



 **NOTE:** Depending on the computer and its installed devices, the items listed in this section may or may not appear

Table 2. General

Option	Description
System Information	<p>Displays the following information:</p> <ul style="list-style-type: none"> • System Information - Displays BIOS Version, Service Tag, Asset Tag, Ownership Tag, Ownership Date, Manufacture Date, and the Express Service Code. • Memory Information - Displays Memory Installed, Memory Available, Memory Speed, Memory Channels Mode, Memory Technology, DIMM 1 Size, DIMM 2 Size, DIMM 3 Size and DIMM 4 Size. • PCI Information - Displays SLOT1, and SLOT2 • Processor Information - Displays Processor Type, Core Count, Processor ID, Current Clock Speed, Minimum Clock Speed, Maximum Clock Speed, Processor L2 Cache, Processor L3 Cache, HT Capable, and 64-Bit Technology. • Device Information - Displays SATA-0, SATA-1, SATA-2 , LOM MAC Address, Audio Controller and Video Controller.
Boot Sequence	<p>Allows you to specify the order in which the computer attempts to find an operating system. The options are:</p> <ul style="list-style-type: none"> • Diskette drive • WDC WD2500AAKX-75U6AA0 • USB Storage Device • CD/DVD/CD-RW Drive • Onboard NIC
Advanced Boot Options	<ul style="list-style-type: none"> • Legacy • UEFI

Option	Description
Advance Boot Options	Enable Legacy Option ROMs - This option is enabled by default.
Date/Time	Allows you to set the date and time. The changes to the system date and time takes effect immediately.

Table 3. System Configuration

Option	Description
Integrated NIC	<p>Allows you to enable or disable the integrated network card. You can set the integrated NIC to:</p> <ul style="list-style-type: none"> • Enable UEFI Network Stack (disable by default) • Disabled • Enabled • Enabled w/PXE- This option is enabled by default. • Enabled w/Cloud Desktop <p> NOTE: Depending on the computer and the devices installed, the items listed in this section may or may not appear.</p>
Serial Port	<p>Allows you to define the serial port settings. You can set the serial port to:</p> <ul style="list-style-type: none"> • Disabled • COM1 • COM2 • COM3 • COM4 <p> NOTE: The operating system may allocate resources even though the setting is disabled.</p>
SATA Operation	<p>Allows you to configure the operating mode of the integrated hard drive controller.</p> <ul style="list-style-type: none"> • Disabled - The SATA controllers are hidden. • ATA - SATA is configured for ATA mode. • AHCI - SATA is configured for AHCI mode.
Drives	<p>Allows you to enable or disable the various on-board drives:</p> <ul style="list-style-type: none"> • SATA-0 • SATA-1 • SATA-2
SMART Reporting	<p>This field controls if the hard drive errors for the integrated drives are reported during system startup. This technology is part of the SMART (Self Monitoring Analysis and Reporting Technology) specification.</p> <ul style="list-style-type: none"> • Enable SMART Reporting - This option is disabled by default.
USB Configuration	<p>This field configures the integrated USB controller. If <i>Boot Support</i> is enabled, the system is allowed to boot any type of USB mass storage devices (HDD, memory key, floppy).</p> <p>If USB port is enabled, device attached to this port is enabled and available for operation system.</p>





Option	Description
	<p>If USB port is disabled, the operation system cannot see any device attached to this port.</p> <p>USB configuration: For Mini-Tower, Small Form Factor the options are:</p> <ul style="list-style-type: none"> • Enable Boot Support • Enable Front USB 2.0 Ports • Enable USB 3.0 Ports • Enable Rear—Left Dual USB 2.0 Ports • Enable Rear —Right Dual USB 2.0 Ports (default value is enable) <p> NOTE: USB keyboard and mouse always work in the BIOS setup irrespective of these settings.</p>
Audio	<p>Allows you to enable or disable the integrated audio controller.</p> <ul style="list-style-type: none"> • Enable Audio - This option is selected by default.

Table 4. Security

Option	Description
Internal HDD_O Password	<p>This field lets you set, change, or delete the administrator (admin) password (sometimes called the setup password). The admin password enables several security features.</p> <p>The drive does not have a password set by default.</p> <ul style="list-style-type: none"> • Enter the old password • Enter the new password • Confirm the new password
Strong Password	<p>Enable strong password - This option is disabled by default.</p>
Password Configuration	<p>This field controls the minimum and maximum number of characters allowed for the admin and system passwords.</p> <ul style="list-style-type: none"> • Admin Password Min • Admin Password Max • System Password Min • System Password Max
Password Bypass	<p>Allows you to bypass the <i>System Password</i> and the internal HDD password prompts during a system restart. This option is disabled by default.</p> <ul style="list-style-type: none"> • Disabled - Always prompt for the system and internal HDD password when they are set. • Reboot Bypass - Bypass the password prompts on restarts (warm boots). <p> NOTE: The system will always prompt for the system and internal HDD passwords when powered on from the off state (a cold boot). Also, the system will always prompt for passwords on any module bay HDDs that may be present.</p>

Option	Description
Password Change	Allows you to determine whether changes to the system and hard disk passwords are permitted when an administrator password is set. <ul style="list-style-type: none"> • Allow Non-Admin Password Changes - This option is enabled by default.
TPM Security	This option lets you control whether the Trusted Platform Module (TPM) in the system is enabled and visible to the operating system. <p>TPM Security - This option is disabled by default.</p> <p> NOTE: Activation, deactivation, and clear options are not affected if you load the setup program's default values. Changes to this option take effect immediately.</p>
Computrace	This field lets you activate or disable the BIOS module interface of the optional <i>Computrace Service</i> from <i>Absolute Software</i> . <ul style="list-style-type: none"> • Deactivate - This option is selected by default. • Disable • Activate
Chassis Intrusion	<ul style="list-style-type: none"> • Enable - This option is selected by default. • Disable • On-Silent
CPU XD Support	Allows you to enable or disable the execute disable mode of the processor. <ul style="list-style-type: none"> • Enable CPU XD Support - This option is enabled by default.
OROM Keyboard Access	Allows you to determine if you access the Option Read Only Memory (OROM) configuration screens via hotkeys during boot. These settings prevent access to the Intel RAID (CTRL+I) or Intel Management Engine BIOS Extension (CTRL+P/F12). <ul style="list-style-type: none"> • Enable - User may enter OROM configuration screens via the hotkey. This option is selected by default. • One-Time Enable - User can enter the OROM configuration screens via the hotkeys during the next boot. After the boot, the setting will revert to disabled. • Disable - User can not enter the OROM configuration screens via the hotkey. <p>This option is set to Enable by default.</p>
Admin Setup Lockout	Allows you to enable or disable the option to enter setup when an admin password is set. <ul style="list-style-type: none"> • Enable Admin Setup Lockout - This option is not set by default.
HDD Protection Support	Allows you to enable or disable the HDD Protection feature <ul style="list-style-type: none"> • HDD Protection Support - This option is not set by default.
Table 5. Secure Boot	
Secure Boot Enable	Allows you to enable or disable Secure Boot feature <ul style="list-style-type: none"> • Disabled - This option is selected by default. • Enabled

 **NOTE:** To enable secure boot, **UEFI** boot mode must be enabled and **Enable Legacy Option ROMs** must be disabled or turned off.

Expert key Management

Allows you to manipulate the security key databases only if the system is in Custom Mode. The **Enable Custom Mode** option is disabled by default. The options are:

- PK
- KEK
- db
- dbx

If you enable the **Custom Mode**, the relevant options for **PK, KEK, db, and dbx** appear. The options are:

- **Save to File**- Saves the key to a user-selected file
- **Replace from File**- Replaces the current key with a key from a user-selected file
- **Append from File**- Adds a key to the current database from a user-selected file
- **Delete**- Deletes the selected key
- **Reset All Keys**- Resets to default setting
- **Delete All Keys**- Deletes all the keys



 **NOTE:** If you disable the Custom Mode, all the changes made will be erased and the keys will restore to default settings.

Table 6. Performance

Option	Description
Multi Core Support	<p>Specifies whether the process will have one or all cores enabled. The performance of some applications will improve with the additional cores.</p> <ul style="list-style-type: none"> • All - This option is enabled by default • 1 • 2 <p> NOTE: To enable Trusted Execution mode, all cores must be enabled.</p>
Intel SpeedStep	<p>Allows you to enable or disable the Intel SpeedStep mode of the processor.</p> <ul style="list-style-type: none"> • Enable Intel SpeedStep - This option is enabled by default.
C States Control	<p>Allows you to enable or disable the additional processor sleep states.</p> <ul style="list-style-type: none"> • C States - This option is enabled by default.
Limit CPUID Value	<p>This field limits the maximum value the processor Standard CPUID Function will support.</p> <ul style="list-style-type: none"> • Enable CPUID Limit - This option is not set by default. <p> NOTE: Some Operating system will not complete installation when the maximum CPUID Function is greater than 3.</p>
Intel TurboBoost	<p>Allows you to enable or disable Intel TurboBoost mode of the processor.</p>



Option	Description
	<ul style="list-style-type: none"> Disabled - Does not allow the TurboBoost driver to increase the performance state of the processor above the standard performance. Enabled - Allows the Intel TurboBoost driver to increase the performance of the CPU or graphics processor.
Rapid Start Technology	<p>Allows you to improve batter life by automatically putting the system into a low power status during after user specified amount of time.</p> <ul style="list-style-type: none"> Intel Rapid Start feature <p> NOTE: Rapid Start Technology will automatically be disabled due to configuration changes:</p> <ul style="list-style-type: none"> Hard Disk Configuration or partition have been changed System or HDD password is enabled A Dell Encryption Accelerator is installed The Block Sleep setting is enabled

Table 7. Power Management

Option	Description
AC Recovery	<p>Specifies how the computer will respond when AC power is applied after an AC power loss. You can set the AC Recovery to:</p> <ul style="list-style-type: none"> Power Off - This option is enabled by default. Power On Last Power State
Auto On Time	<p>This option sets the time of the day when you would like the system to turn on automatically. Time is kept in standard 12-hour format (hour:minutes:seconds). The startup time can be changed by typing the values in the time and A.M./P.M. fields.</p> <ul style="list-style-type: none"> Disabled - The system will not automatically power up. This option is selected by default. Every Day - The system will power up every day at the time you specified above . Weekdays - The system will power up Monday through Friday at the time you specified above. Select Days - The system will power up on days selected above at the time you specified above. <p> NOTE: This feature does not work if you turn off your computer using the switch on a power strip or surge protector or if Auto Power is set to disabled.</p>
Deep Sleep Control	<p>Allows you to define the controls when Deep Sleep is enabled.</p> <ul style="list-style-type: none"> Disabled Enabled in S5 only Enabled in S4 and S5 <p>This option is disabled by default.</p>
Fan Control Override	<p>Controls the speed of the system fan. This option is disabled by default.</p> <p> NOTE: When enabled, the fan runs at full speed.</p>

Option	Description
USB Wake Support	This option allows you to enable USB devices to wake the computer from standby. <ul style="list-style-type: none"> • Enable USB Wake Support - This option is selected by default.
Wake on LAN	This option allows the computer to power up from the off state when triggered by a special LAN signal. Wake-up from the Standby state is unaffected by this setting and must be enabled in the operating system. This feature only works when the computer is connected to AC power supply. The options differ based on the form factor. <ul style="list-style-type: none"> • Disabled - Does not allow the system to power on by special LAN signals when it receives a wake-up signal from the LAN or wireless LAN. • LAN Only - Allows the system to be powered on by special LAN signals. • LAN with PXE Boot - Allows the system to be powered on by special LAN signals. After waking the system, do a PXE boot. <p>This option is Disabled by default.</p>
Block Sleep	This option lets you block entering to sleep (S3 state) in operating system environment. <ul style="list-style-type: none"> • Block Sleep (S3 state) - This option is disabled by default.
Intel Smart Connect Technology	The option is disabled by default. If option enables will periodically sense nearby wireless connection while the system is asleep. It will synchronize emails or social media application that were open when system entered the sleep state. <ul style="list-style-type: none"> • Smart Connect

Table 8. POST Behavior

Option	Description
Numlock LED	Specifies if the NumLock function can be enabled when the system boots. This option is enabled by default.
Keyboard Errors	Specifies whether keyboard related errors are reported when it boots. This option is enabled by default.
MEBx Hotkeys	Specifies whether the MEBx Hotkey function should be enable when the system boots. <ul style="list-style-type: none"> • Enable MEBx Hotkey – This option is enabled by default

Table 9. Virtualization Support





Option	Description
Virtualization	This option specifies whether a Virtual Machine Monitor (VMM) can utilize the additional hardware capabilities provided by Intel Virtualization technology. <ul style="list-style-type: none"> • Enable Intel Virtualization Technology - This option is enabled by default.
VT for Direct I/O	Enables or disables the Virtual Machine Monitor (VMM) from utilizing the additional hardware capabilities provided by Intel® Virtualization technology for direct I/O.

Option	Description
	<ul style="list-style-type: none"> • Enable Intel Virtualization Technology for Direct I/O - This option is enabled by default.
Trusted Execution	<p>This option specifies whether a Measured Virtual Machine Monitor (MVMM) can utilize the additional hardware capabilities provided by Intel Trusted Execution technology. The TPM virtualization technology, and Virtualization technology for direct I/O must be enabled to use this feature.</p> <ul style="list-style-type: none"> • Trusted Execution - This option is disabled by default.

Table 10. Maintenance

Option	Description
Service Tag	Displays the service tag of your computer.
Asset Tag	Allows you to create a system asset tag if an asset tag is not already set. This option is not set by default.
SERR Messages	Controls the SERR message mechanism. This option is not set by default. Some graphics cards require that the SERR message mechanism be disabled.

Table 11. Cloud Desktop

Option	Description
Server Lookup Method	<p>Specifies how the Cloud Desktop software will look up the server addresses.</p> <ul style="list-style-type: none"> • Static IP • DNS - This option is enabled by default. <p> NOTE: This field is only relevant when the <i>Integrated NIC</i> control in the <i>System Configuration</i> group is set to <i>Enable with Cloud Desktop</i>.</p>
Server Name	<p>Specifies server name of the server.</p> <p> NOTE: This field is only relevant when the <i>Integrated NIC</i> control in the <i>System Configuration</i> group is set to <i>Enable with Cloud Desktop</i>.</p>
Server IP Address	<p>Specifies the primary static IP address of the Cloud Desktop server with which the client software communicates. The default IP address is 255.255.255.255.</p> <p> NOTE: This field is only relevant when the <i>Integrated NIC</i> control in the <i>System Configuration</i> group is set to <i>Enable with Cloud Desktop</i>.</p>
Server Port	<p>Specifies the primary IP port of the Cloud Desktop, which is used by the client to communicate. The default IP port is 06910.</p> <p> NOTE: This field is only relevant when the <i>Integrated NIC</i> control in the <i>System Configuration</i> group is set to <i>Enable with Cloud Desktop</i>.</p>
Client Address Method	<p>Specifies how the client obtains the IP address.</p> <ul style="list-style-type: none"> • Static IP • DHCP - This option is enabled by default.







Option	Description
Client IP Address	<p> NOTE: This field is only relevant when the <i>Integrated NIC</i> control in the <i>System Configuration</i> group is set to <i>Enable with Cloud Desktop</i>.</p> <p>Specifies the static IP address of the client. The default IP address is 255.255.255.255.</p>
Client SubnetMask	<p> NOTE: This field is only relevant when the <i>Integrated NIC</i> control in the <i>System Configuration</i> group is set to <i>Enable with Cloud Desktop</i>.</p> <p>Specifies the subnet mask of the client. The default setting is 255.255.255.255.</p>
Client Gateway	<p> NOTE: This field is only relevant when the <i>Integrated NIC</i> control in the <i>System Configuration</i> group is set to <i>Enable with Cloud Desktop</i>.</p> <p>Specifies the gateway IP address of the client. The default setting is 255.255.255.255.</p>
DNS IP Address	<p> NOTE: This field is only relevant when the <i>Integrated NIC</i> control in the <i>System Configuration</i> group is set to <i>Enable with Cloud Desktop</i>.</p> <p>Specifies the DNS IP Address of the client. The default setting is 255.255.255.255.</p>
Domain Name	<p>Specifies the Domain Name of the client.</p> <p> NOTE: This field is only relevant when the <i>Integrated NIC</i> control in the <i>System Configuration</i> group is set to <i>Enable with Cloud Desktop</i>, and when the Client Address Method is set to Static IP.</p>
Advanced	<p>Specifies for Advanced debugging</p> <ul style="list-style-type: none"> • Verbose Mode - This option is not set by default. <p> NOTE: This Option is only relevant when the integrated NIC control in the System Configuration group is set to enable with Cloud Desktop.</p>

Table 12. System Logs

Option	Description
BIOS events	<p>Displays the system event log and allows you to clear the log.</p> <ul style="list-style-type: none"> • Clear Log

Updating the BIOS

It is recommended to update your BIOS (system setup), on replacing the system board or if an update is available. For laptops, ensure that your computer battery is fully charged and connected to a power outlet

1. Re-start the computer.
2. Go to [dell.com/support](https://www.dell.com/support).
3. Enter the **Service Tag** or **Express Service Code** and click **Submit**.

 **NOTE:** To locate the Service Tag, click **Where is my Service Tag?**

 **NOTE:** If you cannot find your Service Tag, click **Detect My Product**. Proceed with the instructions on screen.

4. If you are unable to locate or find the Service Tag, click the Product Category of your computer.
5. Choose the **Product Type** from the list.
6. Select your computer model and the **Product Support** page of your computer appears.
7. Click **Get drivers** and click **View All Drivers**.
The Drivers and Downloads page opens.
8. On the Drivers and Downloads screen, under the **Operating System** drop-down list, select **BIOS**.
9. Identify the latest BIOS file and click **Download File**.
You can also analyze which drivers need an update. To do this for your product, click **Analyze System for Updates** and follow the instructions on the screen.
10. Select your preferred download method in the **Please select your download method below window**; click **Download File**.
The **File Download** window appears.
11. Click **Save** to save the file on your computer.
12. Click **Run** to install the updated BIOS settings on your computer.
Follow the instructions on the screen.

Jumper Settings

To change a jumper setting, pull the plug off its pin(s) and carefully fit it down onto the pin(s) indicated on the system board. The following table displays the system board jumper settings.

Table 13. Jumper Settings

Jumper	Setting	Description
PSWD	Default	Password features are enabled
RTCST	pin 1 and 2	Real-time clock reset. Can be used for troubleshooting.

System and Setup Password

You can create a system password and a setup password to secure your computer.

Password Type	Description
System password	Password that you must enter to log on to your system.
Setup password	Password that you must enter to access and make changes to the BIOS settings of your computer.

 **CAUTION:** The password features provide a basic level of security for the data on your computer.

 **CAUTION:** Anyone can access the data stored on your computer if it is not locked and left unattended.

 **NOTE:** Your computer is shipped with the system and setup password feature disabled.

Assigning a System Password and Setup Password

You can assign a new **System Password** and/or **Setup Password** or change an existing **System Password** and/or **Setup Password** only when **Password Status** is **Unlocked**. If the Password Status is **Locked**, you cannot change the System Password.

 **NOTE:** If the password jumper is disabled, the existing System Password and Setup Password is deleted and you need not provide the system password to log on to the computer.

To enter a system setup, press <F2> immediately after a power-on or re-boot.

1. In the **System BIOS** or **System Setup** screen, select **System Security** and press <Enter>. The **System Security** screen appears.
2. In the **System Security** screen, verify that **Password Status** is **Unlocked**.
3. Select **System Password**, enter your system password, and press <Enter> or <Tab>. Use the following guidelines to assign the system password:
 - A password can have up to 32 characters.
 - The password can contain the numbers 0 through 9.
 - Only lower case letters are valid, upper case letters are not allowed.
 - Only the following special characters are allowed: space, ("), (+), (.), (-), (.), (/), (:), (I), (\), (I), (').

Re-enter the system password when prompted.

4. Type the system password that you entered earlier and click **OK**.
5. Select **Setup Password**, type your system password and press <Enter> or <Tab>. A message prompts you to re-type the setup password.
6. Type the setup password that you entered earlier and click **OK**.
7. Press <Esc> and a message prompts you to save the changes.
8. Press <Y> to save the changes. The computer reboots.

Deleting or Changing an Existing System and/or Setup Password

Ensure that the **Password Status** is **Unlocked** (in the System Setup) before attempting to delete or change the existing System and/or Setup password. You cannot delete or change an existing System or Setup password, if the **Password Status** is **Locked**.

To enter the System Setup, press <F2> immediately after a power-on or reboot.

1. In the **System BIOS** or **System Setup** screen, select **System Security** and press <Enter>. The **System Security** screen is displayed.
2. In the **System Security** screen, verify that **Password Status** is **Unlocked**.
3. Select **System Password**, alter or delete the existing system password and press <Enter> or <Tab>.
4. Select **Setup Password**, alter or delete the existing setup password and press <Enter> or <Tab>.

 **NOTE:** If you change the System and/or Setup password, re-enter the new password when prompted. If you delete the System and/or Setup password, confirm the deletion when prompted.

5. Press <Esc> and a message prompts you to save the changes.
6. Press <Y> to save the changes and exit from the System Setup. The computer reboots.

Disabling a System Password

The system's software security features include a system password and a setup password. The password jumper disables any password(s) currently in use.

 **NOTE:** You can also use the following steps to disable a forgotten password.

1. Follow the procedures in *Before Working on Your Computer*.
2. Remove the cover.
3. Identify the PSWD jumper on the system board.
4. Remove the PSWD jumper from the system board.

 **NOTE:** The existing passwords are not disabled (erased) until the computer boots without the jumper.

5. Install the cover.

 **NOTE:** If you assign a new system and/or setup password with the PSWD jumper installed, the system disables the new password(s) the next time it boots.

6. Connect the computer to the electrical outlet and power-on the computer.
7. Power-off the computer and disconnect the power cable from the electrical outlet.
8. Remove the cover.
9. Replace the PSWD jumper on the system board.
10. Install the cover.
11. Follow the procedures in *After Working on Your Computer*.
12. Power-on the computer.
13. Go to the system setup, and assign a new system or setup password. See *Setting up a System Password*.

Diagnostics

If you experience a problem with your computer, run the ePSA diagnostics before contacting Dell for technical assistance. The purpose of running diagnostics is to test your computer's hardware without requiring additional equipment or risking data loss. If you are unable to fix the problem yourself, service and support personnel can use the diagnostics results to help you solve the problem.

Enhanced Pre-Boot System Assessment (ePSA) Diagnostics

The ePSA diagnostics (also known as system diagnostics) performs a complete check of your hardware. The ePSA is embedded with the BIOS and is launched by the BIOS internally. The embedded system diagnostics provides a set of options for particular devices or device groups allowing you to:

- Run tests automatically or in an interactive mode
- Repeat tests
- Display or save test results
- Run thorough tests to introduce additional test options to provide extra information about the failed device(s)
- View status messages that inform you if tests are completed successfully
- View error messages that inform you of problems encountered during testing



CAUTION: Use the system diagnostics to test only your computer. Using this program with other computers may cause invalid results or error messages.



NOTE: Some tests for specific devices require user interaction. Always ensure that you are present at the computer terminal when the diagnostic tests are performed.

1. Power-on the computer.
2. As the computer boots, press the <F12> key as the Dell logo appears.
3. On the boot menu screen, select the **Diagnostics** option.

The **Enhanced Pre-boot System Assessment** window is displayed, listing all devices detected in the computer. The diagnostics starts running the tests on all the detected devices.

4. If you wish to run a diagnostic test on a specific device, press <Esc> and click **Yes** to stop the diagnostic test.
5. Select the device from the left pane and click **Run Tests**.
6. If there are any issues, error codes are displayed.

Note the error code and contact Dell.

Troubleshooting Your Computer

You can troubleshoot your computer using indicators like Diagnostic Lights, Beep Codes, and Error Messages during the operation of the computer.

Power LED Diagnostics

The power button LED located on the front of the chassis also functions as a bicolored diagnostic LED. The diagnostic LED is only active and visible during the POST process. Once the operating system starts to load, it is no longer visible.

Amber LED blinking scheme – The pattern is 2 or 3 blinks followed by a short pause then x number of blinks up to 7. The repeated pattern has a long pause inserted in the middle. For example 2,3 = 2 amber blinks, short pause, 3 amber blinks followed by long pause then repeats.

Table 14. Power LED Diagnostics

Amber LED State	White LED State	Description
off	off	system is OFF
off	blinking	system is in sleep state
blinking	off	power supply unit (PSU) failure
steady	off	PSU is working but failed to fetch code
off	steady	system is ON

Amber LED State	Description
2,1	system board failure
2,2	system board, PSU or PSU cabling failure
2,3	system board, memory or CPU failure
2, 4	coin-cell battery failure
2,5	corrupt BIOS
2,6	CPU configuration failure or CPU failure
2,7	memory modules are detected, but a memory failure
3,1	possible peripheral card or system board failure
3,2	possible USB failure
3,3	no memory modules are detected
3,4	possible system board error

Amber LED State	Description
3,5	memory modules are detected, but a memory configuration or compatibility error
3,6	possible system board resource and/or hardware failure
3,7	some other failure with messages on screen

Beep Code

The computer can emit a series of beeps during start-up if the display does not show errors or problems. These series of beeps, called beep codes, identify various problems. The delay between each beep is 300 ms, the delay between each set of beeps is 3 sec, and the beep sound lasts 300 ms. After each beep and each set of beeps, the BIOS should detect if the user presses the power button. If so, BIOS will jump out from looping and execute the normal shutdown process and power system.

Code	1-3-2
Cause	Memory failure

Error Messages

Error Message	Description
Address mark not found	The BIOS found a faulty disk sector or could not find a particular disk sector.
Alert! Previous attempts at booting this system have failed at checkpoint [nnnn]. For help in resolving this problem, please note this checkpoint and contact Dell Technical Support.	The computer failed to complete the boot routine three consecutive times for the same error. Contact Dell and report the checkpoint code (nnnn) to the support technician
Alert! Security override Jumper is installed.	The MFG_MODE jumper has been set and AMT Management features are disabled until it is removed.
Attachment failed to respond	The floppy or hard drive controller cannot send data to the associated drive.
Bad command or file name	Ensure that you have spelled the command correctly, put spaces in the proper place, and used the correct pathname.
Bad error-correction code (ECC) on disk read	The floppy or hard drive controller detected an uncorrectable read error.

Error Message	Description
Controller has failed	The hard drive or the associated controller is defective.
Data error	The floppy or hard drive cannot read the data. For the Windows operating system, run the chkdsk utility to check the file structure of the floppy or hard drive. For any other operating system, run the appropriate corresponding utility.
Decreasing available memory	One or more memory modules may be faulty or improperly seated. Re-install the memory modules and, if necessary, replace them.
Diskette drive 0 seek failure	A cable may be loose or the computer configuration information may not match the hardware configuration.
Diskette read failure	The floppy disk may be defective or a cable may be loose. If the drive access light turns on, try a different disk.
Diskette subsystem reset failed	The floppy drive controller may be faulty.
Gate A20 failure	One or more memory modules may be faulty or improperly seated. Reinstall the memory modules and, if necessary, replace them.
General failure	The operating system is unable to carry out the command. This message is usually followed by specific information—for example, Printer out of paper . Take the appropriate action to resolve the problem.
Hard-disk drive configuration error	The hard drive failed initialization.
Hard-disk drive controller failure	The hard drive failed initialization.
Hard-disk drive failure	The hard drive failed initialization.
Hard-disk drive read failure	The hard drive failed initialization.
Invalid configuration information-please run SETUP program	The computer configuration information does not match the hardware configuration.
Invalid Memory configuration, please populate DIMM1	DIMM1 slot does not recognize a memory module. The module should be re-seated or installed.
Keyboard failure	A cable or connector may be loose, or the keyboard or keyboard/mouse controller may be faulty.
Memory address line failure at address, read value expecting value	A memory module may be faulty or improperly seated. Reinstall the memory modules and, if necessary, replace them.

Error Message	Description
Memory allocation error	The software you are attempting to run is conflicting with the operating system, another program, or a utility.
Memory data line failure at address, read value expecting value	A memory module may be faulty or improperly seated. Reinstall the memory modules and, if necessary, replace them.
Memory double word logic failure at address, read value expecting value	A memory module may be faulty or improperly seated. Reinstall the memory modules and, if necessary, replace them.
Memory odd/even logic failure at address, read value expecting value	A memory module may be faulty or improperly seated. Reinstall the memory modules and, if necessary, replace them.
Memory write/read failure at address, read value expecting value	A memory module may be faulty or improperly seated. Reinstall the memory modules and, if necessary, replace them.
Memory size in CMOS invalid	The amount of memory recorded in the computer configuration information does not match the memory installed in the computer.
Memory tests terminated by keystroke	A keystroke interrupted the memory test.
No boot device available	The computer cannot find the floppy disk or hard drive.
No boot sector on hard-disk drive	The computer configuration information in System Setup may be incorrect.
No timer tick interrupt	A chip on the system board might be malfunctioning.
Non-system disk or disk error	The floppy disk in drive A does not have a bootable operating system installed on it. Either replace the floppy disk with one that has a bootable operating system, or remove the floppy disk from drive A and restart the computer.
Not a boot diskette	The operating system is trying to boot to a floppy disk that does not have a bootable operating system installed on it. Insert a bootable floppy disk.
Plug and play configuration error	The computer encountered a problem while trying to configure one or more cards.
Read fault	The operating system cannot read from the floppy or hard drive, the computer could not find a particular sector on the disk, or the requested sector is defective.
Requested sector not found	The operating system cannot read from the floppy or hard drive, the computer could not find a particular sector on the disk, or the requested sector is defective.

Error Message	Description
Reset failed	The disk re-set operation failed.
Sector not found	The operating system cannot locate a sector on the floppy or hard drive.
Seek error	The operating system cannot find a specific track on the floppy disk or hard drive.
Shutdown failure	A chip on the system board might be malfunctioning.
Time-of-day clock stopped	The battery might be dead.
Time-of-day not set-please run the System Setup program	The time or date stored in System Setup does not match the computer clock.
Timer chip counter 2 failed	A chip on the system board may be malfunctioning.
Unexpected interrupt in protected mode	The keyboard controller may be malfunctioning or a memory module may be loose.
WARNING: Dell's Disk Monitoring System has detected that drive [0/1] on the [primary/secondary] EIDE controller is operating outside of normal specifications. It is advisable to immediately back up your data and replace your hard drive by calling your support desk or Dell.	During initial startup, the drive detected possible error conditions. When your computer finishes booting, immediately back up your data and replace your hard drive (for installation procedures, see "Adding and Removing Parts" for your computer type). If no replacement drive is immediately available and the drive is not the only bootable drive, enter System Setup and change the appropriate drive setting to None . Then remove the drive from the computer.
Write fault	The operating system cannot write to the floppy or hard drive.
Write fault on selected drive	The operating system cannot write to the floppy or hard drive.

Specifications



 **NOTE:** Offerings may vary by region. For more information regarding the configuration of your computer, click Start  (**Start icon**) → **Help and Support**, and then select the option to view information about your computer.

Table 15. Processor

Feature	Specification
Processor type	<ul style="list-style-type: none"> Intel Core i3/i5/i7 series Intel Dual Core series
Total Cache	Up to 8 MB cache depending on processor type

Table 16. Memory

Feature	Specification
Type	DDR3
Speed	1600MHz
Connectors:	
Mini-Tower, Small Form Factor	four DIMM slots
Capacity	2 GB, 4 GB, and 8 GB
Minimum Memory	2 GB
Maximum memory	16 GB

Table 17. Video

Feature	Specification
Integrated	Intel HD Graphics 4600 (i3/i5/i7 DC/QC Intel 8 Series Express chipset CPU-GPU Combo) and Intel HD Graphics (Pentium CPU-GPU)
Discrete	PCI Express x16 graphics adapter

Table 18. Audio

Feature	Specification
Integrated	two channel High Definition Audio

Table 19. Network

Feature	Specification
Integrated	Intel I217LM Ethernet capable of 10/100/1000 Mb/s communication

Table 20. System Information

Feature	Specification
System chipset	Intel 8 series Express chipset
DMA Channels	two 8237 DMA controllers with seven independently programmable channels
Interrupt Levels	Integrated I/O APIC capability with 24 interrupts
BIOS Chip (NVRAM)	12 MB

Table 21. Expansion Bus

Feature	Specification
Bus Type	PCIe gen2, gen3 (x16), USB 2.0, and USB 3.0
Bus Speed	PCI Express: <ul style="list-style-type: none"> • x1-slot each direction speed –500 MB/s • x16-slot each direction speed–16 GB/s SATA: 1.5 Gbps, 3.0 Gbps, and 6 Gbps

Table 22. Cards

Feature	Specification
PCI:	
Mini-Tower	up to one full-height card
Small Form Factor	none
PCI Express x1:	
Mini-Tower	up to three full-height cards
Small Form Factor	up to two low-profile cards
PCI-Express x16:	
Mini-Tower	up to two full-height cards
Small Form Factor	up to two low-profile cards

Table 23. Drives

Feature	Specification
Externally Accessible (5.25-inch drive bays):	
Mini-Tower	two

Feature	Specification
Small Form Factor	one slim-optical drive bay
Internally Accessible	
3.5-inch SATA drive bays:	
Mini-Tower	two
Small Form Factor	one
2.5-inch SATA drive bays:	
Mini-Tower	two
Small Form Factor	two

Table 24. External Connectors

Feature	Specification
Audio:	
Front Panel	<ul style="list-style-type: none"> one microphone connector one headphone connector
Back Panel	<ul style="list-style-type: none"> one line-out connector one line-in/microphone connector
Network Adapter	one RJ45 connector
Serial	one 9-pin connector; 16550 C compatible
Parallel	one 25-pin connector (optional for minitower and small form factor)
USB 2.0:	<ul style="list-style-type: none"> Front Panel: two Back Panel: four
USB 3.0:	<ul style="list-style-type: none"> Front Panel: two Back Panel: two
Video	<ul style="list-style-type: none"> 15-pin VGA connector two 20-pin DisplayPort connectors
	 NOTE: Available video connectors may vary based on the graphics card selected.

Table 25. Internal Connectors

Feature	Specification
PCI 2.3 data width (maximum) – 32 bits	
Mini-Tower	one 120-pin connector

Feature	Specification
Small Form Factor	none
PCI Express x1 data width (maximum) – one PCI Express lane	
Mini-Tower	one 36-pin connector
Small Form Factor	none
PCI Express x16 (wired as x4) data width (maximum) – four PCI Express lanes	
Mini-Tower	one 164-pin connector
Small Form Factor	one 64-pin connector
PCI Express x16 data width (maximum) – 16 PCI Express lanes	
Mini-Tower, Small Form Factor	one 164-pin connector
Mini PCI Express data width (maximum) – one PCI Express lane and one USB interface	
Mini-Tower, Small Form Factor	none
Serial ATA:	
Mini-Tower	four 7-pin connectors
Small Form Factor	three 7-pin connectors
Memory:	
Mini-Tower, Small Form Factor	four 240-pin connectors
Internal USB:	
Mini-Tower	one 10-pin connector
Small Form Factor	none
System Fan	one 5-pin connector
Front panel control:	
Mini-Tower	<ul style="list-style-type: none"> • one 6-pin connector • two 20-pin connector
Small Form Factor	<ul style="list-style-type: none"> • one 6-pin connector • one 10-pin connector • one 12-pin connector • one 20-pin connector
Thermal Sensor:	
Mini-Tower	one 2-pin connector
Small Form Factor	none
Processor	one 1150-pin connector
Processor Fan	one 5-pin connector
Service mode jumper	one 2-pin connector

Feature	Specification
Password clear jumper	one 2-pin connector
RTC reset jumper	one 2-pin connector
Internal speaker	one 5-pin connector
Intruder connector	one 3-pin connector
Power connector: Mini-Tower, Small Form Factor	one 8-pin, one 4-pin, one 6-pin, connector

Table 26. Controls and Lights

Feature	Specification
Front of the computer:	
Power button light	White light — Solid white light indicates power-on state; blinking white light indicates sleep state of the computer.
Drive activity light	White light — Blinking white light indicates that the computer is reading data from or writing data to the hard drive.
Back of the computer:	
Link integrity light on integrated network adapter	Green — a good 10 Mbps connection exists between the network and the computer. Green — a good 100 Mbps connection exists between the network and the computer. Orange — a good 1000 Mbps connection exists between the network and the computer. Off (no light) — the computer is not detecting a physical connection to the network.
Network activity light on integrated network adapter	Yellow light — A blinking yellow light indicates that network activity is present.
Power supply diagnostic light	Green light — The power supply is turned on and is functional. The power cable must be connected to the power connector (at the back of the computer) and the electrical outlet.

Table 27. Power**NOTE:** Heat dissipation is calculated by using the power supply wattage rating.

	Wattage	Maximum Heat Dissipation	Voltage
Mini-Tower	290 W	989.00 BTU/hr	100 VAC to 240 VAC, 50 Hz to 60 Hz, 5 A
Small Form Factor	255 W	870.00 BTU/hr	100 VAC to 240 VAC, 50 Hz to 60 Hz, 4.4 A
Coin-cell battery		3 V CR2032 lithium coin cell	

Table 28. Physical Dimension

	Height	Width	Depth	Weight
Mini-Tower	36.00 cm (14.17 inches)	17.50 cm (6.89 inches)	41.70 cm (16.42 inches)	9.40 kg (20.72 lb)
Small Form Factor	29.00 cm (11.42 inches)	9.30 cm (3.66 inches)	31.20 cm (12.28 inches)	6.00 kg (13.22 lb)

Table 29. Environmental

Feature	Specification
Temperature range:	
Operating	5 °C to 35 °C (41 °F to 95 °F)
Storage	-40 °C to 65 °C (-40 °F to 149 °F)
Relative humidity (maximum):	
Operating	20 percent to 80 percent (non-condensing)
Storage	5 percent to 95 percent (non-condensing)
Maximum vibration:	
Operating	0.26 GRMS
Storage	2.20 GRMS
Maximum shock:	
Operating	40 G
Storage	105 G
Altitude:	
Operating	-15.2 m to 3048 m (-50 to 10,000 ft)
Storage	-15.20 m to 10,668 m (-50 ft to 35,000 ft)
Airborne contaminant level	G1 or lower as defined by ANSI/ISA-S71.04-1985

Contacting Dell

 **NOTE:** If you do not have an active Internet connection, you can find contact information on your purchase invoice, packing slip, bill, or Dell product catalog.

Dell provides several online and telephone-based support and service options. Availability varies by country and product, and some services may not be available in your area. To contact Dell for sales, technical support, or customer service issues:

Go to dell.com/contactdell.